

# TASCAM

D01396920C

# Mixcast 4

## Podcast Recording Console

### Reference Manual

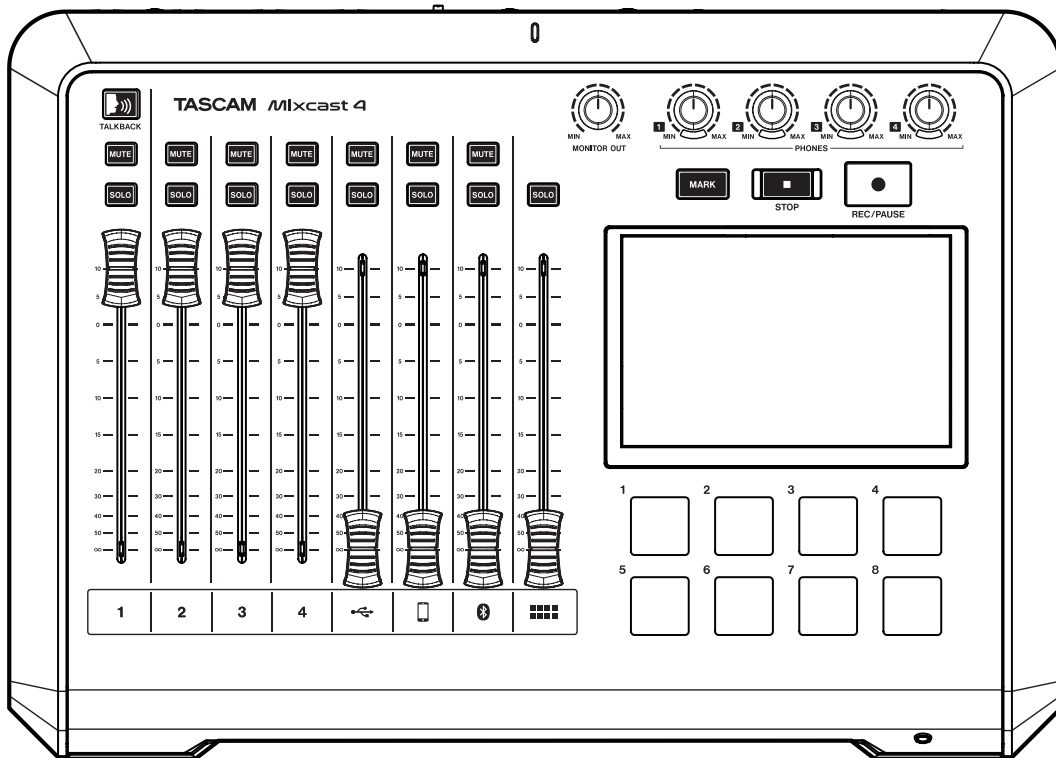

# Contents

<b>1 - Introduction</b> .....	<b>3</b>	8-2-1-2. Condenser/Dynamic (mic type) selection .....	27
Features .....	3	8-2-1-3. Front/Rear input switch (MIC INPUT1 only).....	28
Conventions used in this manual .....	3	8-2-1-4. Voice Setting.....	28
Trademarks.....	3	8-2-1-5. Effect Setting .....	30
USB cables.....	4	8-2-2. USB settings.....	32
Bluetooth® .....	4	8-2-2-1. USB input level.....	32
Profiles.....	4	8-2-2-2. Voice settings.....	32
Codecs.....	4	8-2-3. Smartphone settings .....	33
Content protection.....	4	8-2-3-1. Smartphone input level.....	33
Transmission security .....	4	8-2-3-2. Voice settings.....	33
About SD cards.....	4	8-2-4. Bluetooth settings .....	33
TASCAM ID registration.....	4	8-2-4-1. Bluetooth input level.....	33
<b>2 - Names and Functions of Parts</b> .....	<b>5</b>	8-2-4-2. Pairing .....	33
Top panel.....	5	8-2-4-3. Connection status.....	33
Rear panel.....	6	8-2-4-4. Voice Setting.....	33
Home Screen.....	7	8-3. Playback settings .....	33
<b>3 - Preparation</b> .....	<b>8</b>	8-4. Sound pad settings .....	34
Making connections.....	8	8-5. Hardware Settings.....	35
Connecting audio equipment.....	8	8-5-1. AUDIO.....	36
Connecting the power .....	9	8-5-1-1. USB Mix-Minus .....	36
Turning the power on and off .....	9	8-5-1-2. Auto Mixer .....	36
Tutorial overview.....	9	8-5-1-3. Feedback Prevention .....	36
Connecting microphones .....	10	8-5-1-4. Line Level Output.....	36
Connecting headphones .....	10	8-5-1-5. Solo Mode.....	36
Making USB connections .....	11	8-5-2. MULTI TRACK.....	36
Connecting smartphones, media players and similar devices.....	11	8-5-2-1. SD Multi Record .....	36
Connecting recording devices and monitor speakers .....	11	8-5-2-2. FX Bypass .....	36
Connecting with Bluetooth devices.....	11	8-5-3. USB DELAY .....	36
SD card insertion, removal and write protection .....	12	8-5-3-1. USB delay function explanation .....	36
<b>4 - Input Settings</b> .....	<b>13</b>	8-5-4. Other settings.....	36
Adjusting input levels, audio characteristics and effects .....	13	8-5-4-1. Language .....	36
Lowering knob and fader volumes.....	13	8-5-4-2. Date/ Time Adjust .....	37
Selecting mics for adjustment.....	13	8-5-4-3. Factory Reset .....	37
Adjusting mic input levels .....	13	8-5-4-4. Firmware version.....	37
Adjusting mic input audio characteristics (Voice Setting).....	14	8-5-5. Brightness adjustment.....	37
Adjusting mic input effects (Effect Setting).....	15	8-5-6. AUTO POWER OFF.....	37
<b>5 - Recording and Playback</b> .....	<b>17</b>	8-6. SD Settings.....	37
Recording.....	17	8-6-1. SD card space used.....	37
Adding effect sounds while recording .....	18	8-6-2. SD card available recording time .....	37
Adding marks while recording.....	18	8-6-3. SD REC.....	37
Playing recordings .....	18	8-6-4. Rec Stop confirmation.....	37
Changing the names of podcasts .....	19	8-6-5. SD Device Mode .....	37
Deleting podcasts.....	19	8-6-6. Quick Erase .....	38
Adding marks during playback.....	19	8-6-7. Full Erase.....	38
Advanced playback functions.....	20	<b>9 - Error messages</b> .....	<b>39</b>
Overwrite recording.....	21	<b>10 - Troubleshooting</b> .....	<b>40</b>
Overwrite recording from an added mark.....	21	<b>11 - Specifications and Ratings</b> .....	<b>42</b>
Using TALKBACK functions .....	21	Recorder specifications.....	42
<b>6 - Using TASCAM Podcast Editor</b> .....	<b>22</b>	Analog audio input ratings.....	42
Sound settings when using with Windows OS.....	22	Analog audio output ratings.....	42
Using with Mac OS (audio settings) .....	22	Audio performance .....	42
Using with iOS/iPadOS/Android devices.....	22	Recording times (in hours: minutes) .....	42
Data output by USB.....	22	USB specification.....	43
<b>7 - Using Sound Pads</b> .....	<b>23</b>	USB Audio .....	43
Sound Pad overview .....	23	Bluetooth .....	43
Explanation of Sound Pad Screen functions .....	23	Computer system requirements.....	43
Playing Sound Pads.....	24	Windows.....	43
Assigning effects to Sound Pads .....	24	Mac.....	43
Clearing Sound Pad effect functions .....	25	iOS/iPadOS devices .....	43
Recording sounds and assigning them to Sound Pads.....	25	Android devices.....	43
<b>8 - Touchscreen Functions</b> .....	<b>27</b>	Other.....	43
8-1. Menu Screen.....	27	Dimensional drawings.....	44
8-2. Input selection.....	27	Block diagram.....	45
8-2-1. Mic settings.....	27	Level diagram .....	46
8-2-1-1. Mic input level.....	27		

## Features

- Mixer that supports creation and distribution of podcasts with up to 4 participants
- 4 TRS/XLR combo jack mic inputs
- Phantom power can be activated for inputs individually
- Multitrack recording directly to SD cards possible with up to 14 tracks
- 14-in/2-out USB audio interface functions
- 4 headphone output jacks with independent volume controls
- Auto Mixer function can keep output levels uniform and regulate volume without distortion
- Bluetooth connection enables wireless recording of call audio
- 8 large illuminated sound pads are easy to press and have 8 banks
- 5-inch color touchscreen enables easy and intuitive operation
- Included (downloadable) free TASCAM Podcast Editor app covers all aspects of use

## Conventions used in this manual

In this manual, we use the following conventions:

- SD/SDHC/SDXC memory cards are referred to as "SD cards".
- Computers, portable audio devices and other equipment connected to this unit using Bluetooth are called "Bluetooth devices".
- References to "iOS" in this document also include "iPad OS".
- Information shown on the touchscreen is written like this: "OK".
- Touchscreen operations are indicated as "tap" when a finger is used to touch an icon and "swipe" when moving left or right on the screen.
- The "dedicated software" is TASCAM Podcast Editor.
- Additional information is introduced in the styles below when needed:

### TIP

These are tips about how to use the unit.

### NOTE

These provide additional explanations and describe special cases.

### ATTENTION

Failure to follow these instructions could result in damage to equipment or lost data, for example.

### CAUTION

Failure to follow these instructions could result in injury.

## Trademarks

- TASCAM is a registered trademark of TEAC Corporation.
- SDXC Logo is a trademark of SD-3C, LLC.



- The Bluetooth® word mark and logo are the property of Bluetooth SIG, Inc. and are used by TEAC Corporation with permission.
- Microsoft and Windows are either registered trademarks or trademarks of Microsoft Corporation in the United States and/or other countries.
- Apple, Mac, macOS, iPad, iPadOS, Lightning, App Store and iTunes are trademarks of Apple Inc. in the United States and other countries.
- App Store is a service mark of Apple Inc.
- IOS is a trademark or registered trademark of Cisco in the U.S. and other countries and is used under license.
- Android, Google Play and Google Play logo are trademarks of Google Inc.
- ASIO is a trademark of Steinberg Media Technologies GmbH.



- Other company names, product names and logos in this document are the trademarks or registered trademarks of their respective owners.

**Information is given about products in this manual only for the purpose of example and does not indicate any guarantees against infringements of third-party intellectual property rights and other rights related to them. TEAC Corporation will bear no responsibility for infringements on third-party intellectual property rights or other liabilities that occur as a result of the use of this product.**

**Properties copyrighted by third parties cannot be used for any purpose other than personal enjoyment and the like without the permission of the right holders recognized by copyright law. Always use this equipment properly. TEAC Corporation will bear no responsibility for rights infringements committed by users of this product.**

# 1 - Introduction

---

## USB cables

---

This unit has a USB Type-C port.

Use the included USB cable (Type-C to Type-C) to connect a computer or smartphone to this unit.

If the USB port of the computer or smartphone being connected is not Type-C, however, a different USB cable must be prepared.

- **Connecting to an iOS device with a lightning port**

A genuine Apple Lightning to USB Camera Adapter and a commercially-available Type-A to Type-C cable are necessary.

- **Connecting to a computer or smartphone (that supports OTG) with a USB micro-B port**

A micro-B to Type-C cable (compatible with USB OTG) is necessary.

- **Connecting to a computer with a USB Type-A port**

A commercially-available Type-A to Type-C cable is necessary.

---

## Bluetooth®

---

This unit has a built-in Bluetooth audio module. This allows input of sound played on Bluetooth devices—computers and portable audio devices that support Bluetooth (A2DP)—as well as output of sound from this unit to other Bluetooth devices.

- The Bluetooth function of this unit is not guaranteed to enable connection or operation with all Bluetooth devices.

---

## Profiles

---

This unit supports the following Bluetooth profiles.

- A2DP(Advanced Audio Distribution Profile)

In order to transfer audio by Bluetooth, the Bluetooth device must support A2DP.

Even if a Bluetooth device supports the same profiles, though, its functions might differ according to its specifications.

---

## Codecs

---

This unit supports the following codecs. It will automatically select one of them during audio transfer.

- SBC
- AAC

The unit will select the appropriate codec to use according to the codec compatibility of the other Bluetooth device and communication conditions.

### NOTE

- You cannot select the codec to be used by pressing a button, for example.
- Due to characteristics of Bluetooth wireless technology, playback from this unit will be slightly delayed compared to playback from the Bluetooth device.

---

## Content protection

---

This unit supports SCMS-T as a form of content protection when transmitting audio, so it can play protected audio.

---

## Transmission security

---

This unit supports security functions during Bluetooth transmission in accordance with the Bluetooth standard specifications, but it does not guarantee the privacy of such transmissions.

TEAC CORPORATION will bear no responsibility should an information leak occur during transmission by Bluetooth.

---

## About SD cards

---

A card is necessary to record and play files with this unit. Prepare one for use.

This unit can use SD cards that are Class 10 or higher and compatible with SD, SDHC or SDXC standards.

A list of SD cards that have been confirmed for use with this unit can be found by accessing the TEAC Global Site (<https://teac-global.com>).

Check the page for this product.

You can also contact TASCAM customer support service.

---

## TASCAM ID registration

---

To use the TASCAM Podcast Editor software designed for use with this unit, please create an account on the TASCAM website.

<https://tascamid.tascam.jp/int/login/>

## 2 - Names and Functions of Parts

### Top panel

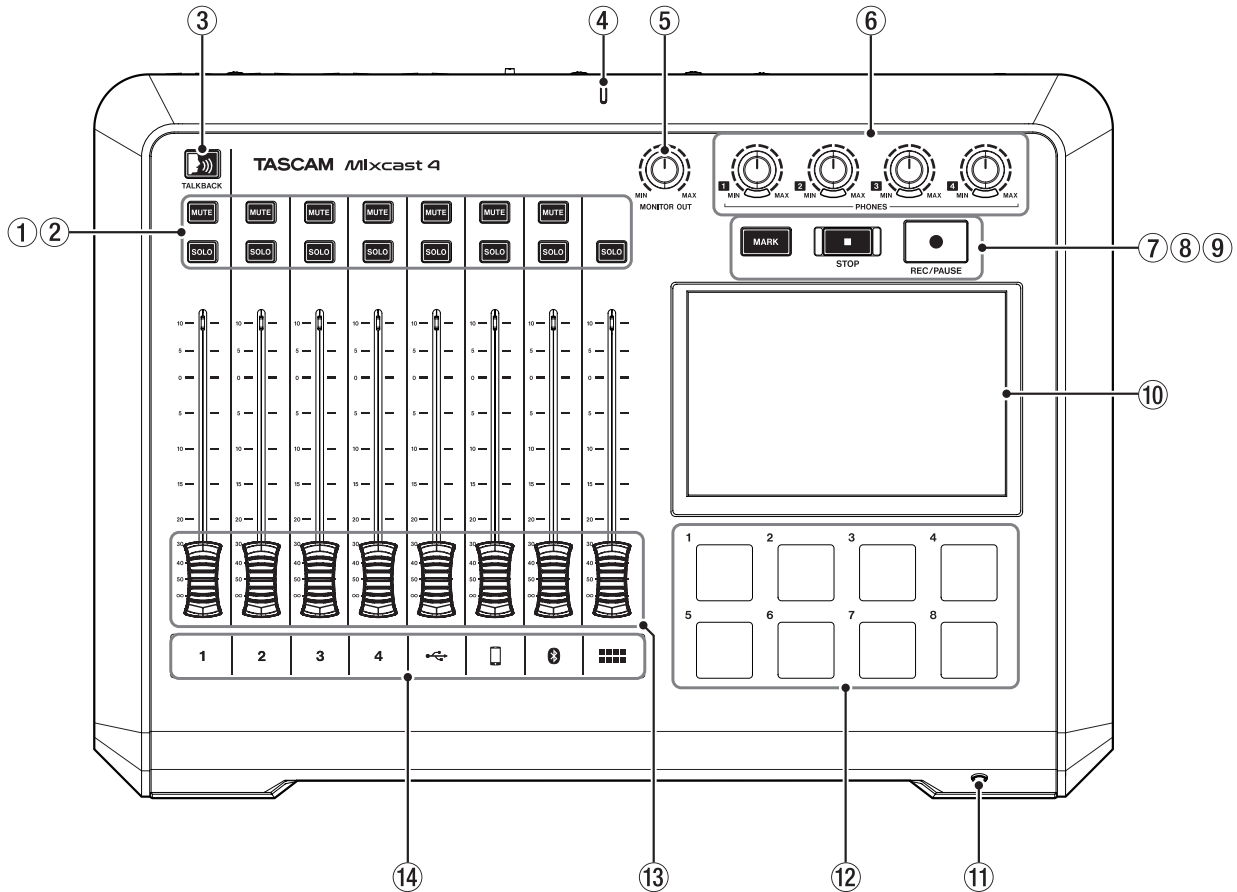

#### ① MUTE buttons

Pressing a MUTE button mutes (silences) the signal input on that channel.

- These light red when on.

#### ② SOLO buttons

Pressing a SOLO button enables the signal input on that channel to be monitored by itself through the PHONES 1 jack on the back or the PHONES (TRRS) **1** jack on the front. (This does not affect recording.)

- These light blue when on.

#### ③ TALKBACK button

While this button is being pressed, the signal input through MIC INPUT 1 is output through the PHONES 2–4 jacks on the back. (This sound will not be recorded when recording.)

- This button lights blue while being pressed.

#### ④ Recording indicator

- This lights red while recording.

#### ⑤ MONITOR OUT knob

Use this to adjust the output of the MONITOR OUT and LINE OUT jacks on the back.

#### ⑥ PHONES **1** - **4** knobs

Connect these to the PHONES **1** - **4** jacks on the back or the PHONES (TRRS) **1** jack on the front.

#### ⑦ MARK button

When playing, recording or paused, press this button to add a mark at the current point.

- This lights blue during playback/recording as well as when playback/recording is paused.

#### ⑧ STOP button

Press this to stop playback or recording.

- This lights orange during playback and recording as well as when recording is paused.

#### ⑨ REC/PAUSE button

Press this to start recording. When recording, press this to pause.

- This lights red while recording and blinks red when recording is paused.

#### ⑩ Touchscreen

This allows input signals to be monitored and shows the operation status of the unit. Various settings can be made by touch operation. (See "Touchscreen Functions" on page 27.)

#### ⑪ PHONES (TRRS) **1** jack (CTIA standard)

Connect a headset, for example, here.

A headset mic can be input on channel 1 using a menu setting. (CTIA standard)

(See "Connecting headsets (switching Mic 1 input)" on page 10.)

#### ⑫ SOUND PAD buttons (1-8)

This allows input signals to be monitored and shows the operation status of the unit. Use the TASCAM Podcast Editor software to set the audio sources.

(See "Sound Pad overview" on page 23.)

#### ⑬ Channel faders

Use these to adjust the send levels of channel signals.

#### ⑭ Channel indicators

- The channel LEDs light red when input overloads are detected. (Adjust input levels if they light frequently.)

1/2/3/4	MIC INPUT 1-4 input signals
	USB input signals
	LINE IN L/R or LINE IN (TRRS) input signals
	Bluetooth input signals
	Sound pad playback sounds

## 2 - Names and Functions of Parts

### Rear panel

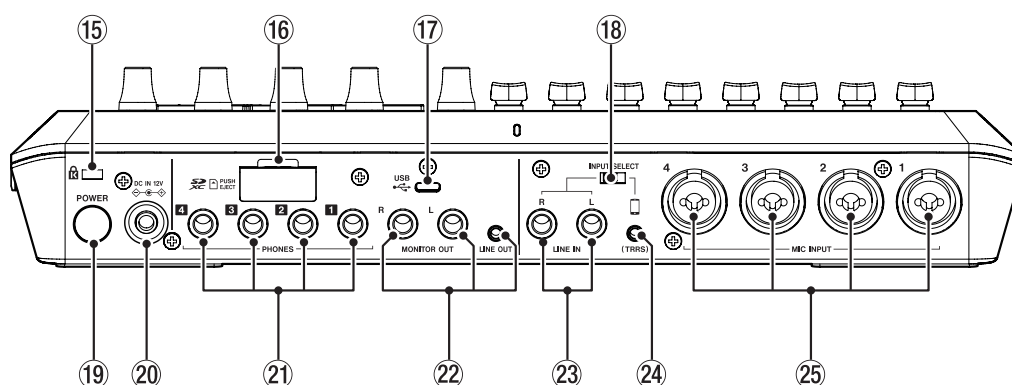

#### 15 Kensington Security Slot

#### 16 SD card slot

Use this slot to insert SD cards.  
(See "Loading SD cards" on page 12.)

#### 17 USB port (Type-C)

This is a USB Type-C port. (This supports USB 2.0.)  
Use this to connect a computer, smartphone or tablet.  
(See "Making USB connections" on page 11.)

#### 18 INPUT SELECT switch

Use this to switch between the LINE IN L/R and LINE IN (TRRS) inputs.

#### 19 POWER button

Press this to turn the unit on and off.  
(See "Turning the power on and off" on page 9.)

#### 20 DC IN 12V connector

Connect the included AC adapter (PS-P1220E NUT) here.  
(See "Connecting the power" on page 9.)

#### 21 PHONES 1 - 4 jacks

Use these standard 6.3mm stereo jacks to connect headphones.  
Use adapters (3.5mm stereo mini jack) to connect headphones with mini plugs.  
(See "Connecting headphones" on page 10.)

#### CAUTION

Before connecting headphones, minimize the volumes with the PHONES 1-4 knobs (6). Failure to do so might cause sudden loud noises, which could harm your hearing or result in other trouble.

#### 22 MONITOR OUT L/R and LINE OUT jacks

Connect monitor speakers (powered speakers or an amplifier and speaker system) to the SUB OUTPUT L/R jacks.  
Use the MONITOR OUT knob (5) on the top to adjust the output levels.

- MONITOR OUT L/R jacks  
Connectors: 6.3mm (1/4") standard TRS jacks
- LINE OUT jack  
Connector: 3.5mm (1/8") stereo mini jack  
(See "Connecting recording devices and monitor speakers" on page 11.)

#### CAUTION

Before turning the power on and connecting monitor speakers, minimize the volume with the MONITOR OUT knob (5) on the top. Failure to do so might cause sudden loud noises, which could harm your hearing or result in other trouble.

#### 23 LINE IN L/R jacks

Connect a media player or other audio device here.

- Set the INPUT SELECT switch to the LINE IN side to use these.  
Connectors: 6.3mm (1/4") standard TRS jacks  
(See "Connecting smartphones, media players and similar devices" on page 11.)

#### 24 LINE IN (TRRS) jack (CTIA standard)

Connect a smartphone or other portable device here.

- Set the INPUT SELECT switch (18) to  (CTIA standard)  
Connector: 3.5 mm (1/8") 4-pole mini jack  
(See "Connecting smartphones, media players and similar devices" on page 11.)

#### 25 MIC INPUT 1-4 jacks

Connect dynamic and condenser mics to these.  
(For mic connection and mic type selection, See "Connecting microphones" on page 10 and See "Mic settings" on page 27.)

#### CAUTION

When "Condenser" is selected for a MIC INPUT jack in the mic settings, phantom power (+48V) will be turned on. Doing so could damage dynamic mics if they are connected.  
Be careful when connecting mics and selecting mic types.

### Home Screen

When the unit is turned on, the Home Screen appears on the touchscreen as shown below.

As a rule, touchscreen operations are either touching an icon with a finger (hereafter, "tap") or moving left/right on the screen (hereafter, "swipe"). (If the response to fingers is poor, operation using a stylus designed for smartphones and tablets is also possible.)

This screen allows input signal levels to be monitored and shows the operation status of the unit. In addition, various function settings can be accessed by tapping the Menu icon on the screen.

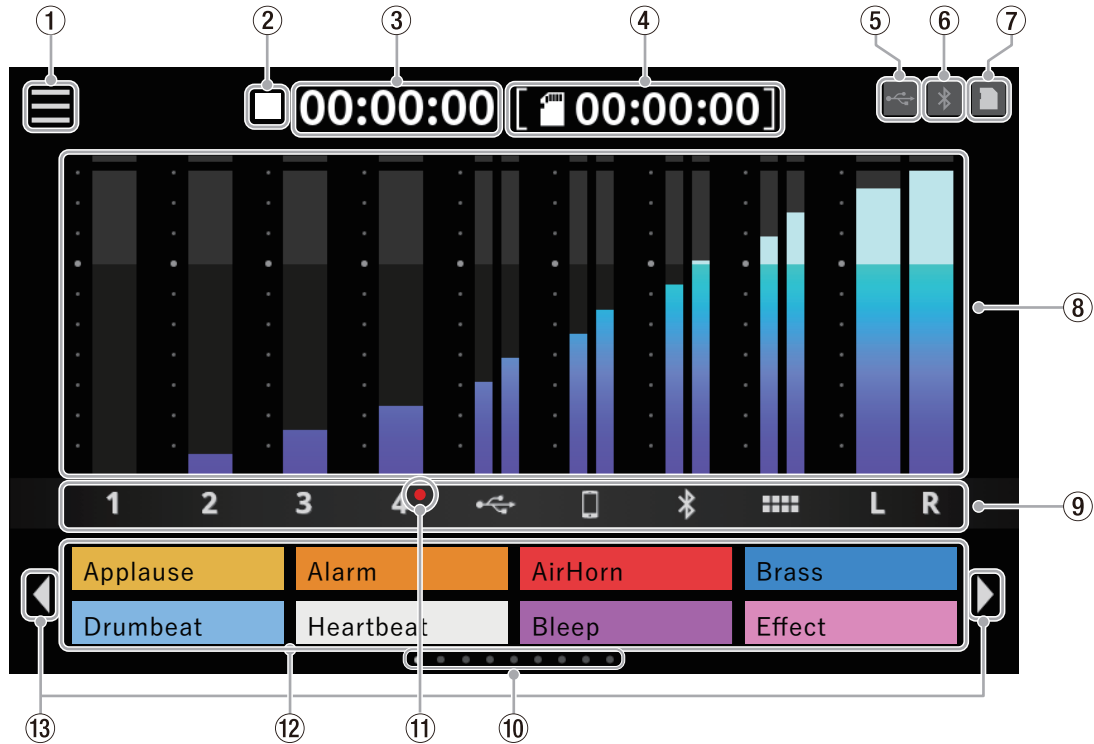

#### ① Menu icon

Tap this icon to open the Menu Screen.  
(See "Menu Screen" on page 27.)

#### ② Recorder operation status

This icon shows the recorder operation status.

Indicator	Meaning
■	Stop
●	Recording
●	Recording paused

#### ③ Recording counter

This shows the current elapsed time (in hours: minutes: seconds) when recording.

#### ④ SD counter

This shows the remaining time available for recording on the SD card (in hours: minutes: seconds).

#### ⑤ USB icon

The icon appears when connected by USB.

#### ⑥ Bluetooth icon

The icon appears when a Bluetooth device is connected.  
The icon blinks when waiting to pair.

#### ⑦ SD card icon

When an SD card is loaded, the icon appears.

#### ⑧ Level meters

These show the levels of the channels.

**1 - 4, , , ,**  Levels sent to the stereo mix  
**L/R** Stereo mix levels

#### ⑨ Input channel identifiers

Indicator	Corresponding input jacks
<b>1 - 4</b>	MIC INPUT 1-4 jacks
	USB port
	LINE IN (TRRS) jack
	Bluetooth input
	Sound pads
<b>L/R</b>	2MIX

#### ⑩ SOUND PAD bank indicator

The position of the SOUND PAD bank currently shown is highlighted.

#### ⑪ Condenser mic selected indicator

Red dots will be shown next to mic channel numbers set to "Condenser" in the mic settings.

#### ⑫ Sound Pad display

These show the names of the audio files that have been assigned to the Sound Pads.\*

Use the dedicated software to set audio sources.

(See "Sound Pad overview" on page 23.)

\*Pre-assigned effect sounds (included audio sources) are set for the Bank 0 Sound Pads.

#### ⑬ SOUND PAD bank switch( / ) icons

Tap the icon to switch to the lower bank. Tap the icon to switch to the higher bank.

# 3 - Preparation

## Making connections

### Connecting audio equipment

The following is an example of connections with this unit.

#### Precautions before making connections

- Carefully read the operation manuals of the devices to be connected and then connect them correctly.
- Before making connections, turn this unit and all equipment to be connected off (standby).
- Install all connected devices, including this unit, so that they are powered from the same line. When using a power strip or similar device, be sure to use one that has high current capacity (thick cable) in order to minimize fluctuations in power voltage.

#### CAUTION

Before turning the power on or connecting audio equipment, set the following knobs and faders on this unit and the knobs and faders of the devices being connected to their lowest values. Failure to do so could cause sudden loud noises from monitoring equipment, and this could damage the equipment or harm hearing.

- Channel faders (13), PHONES 1-4 knobs (6), MONITOR OUT knob (5)

Connection example

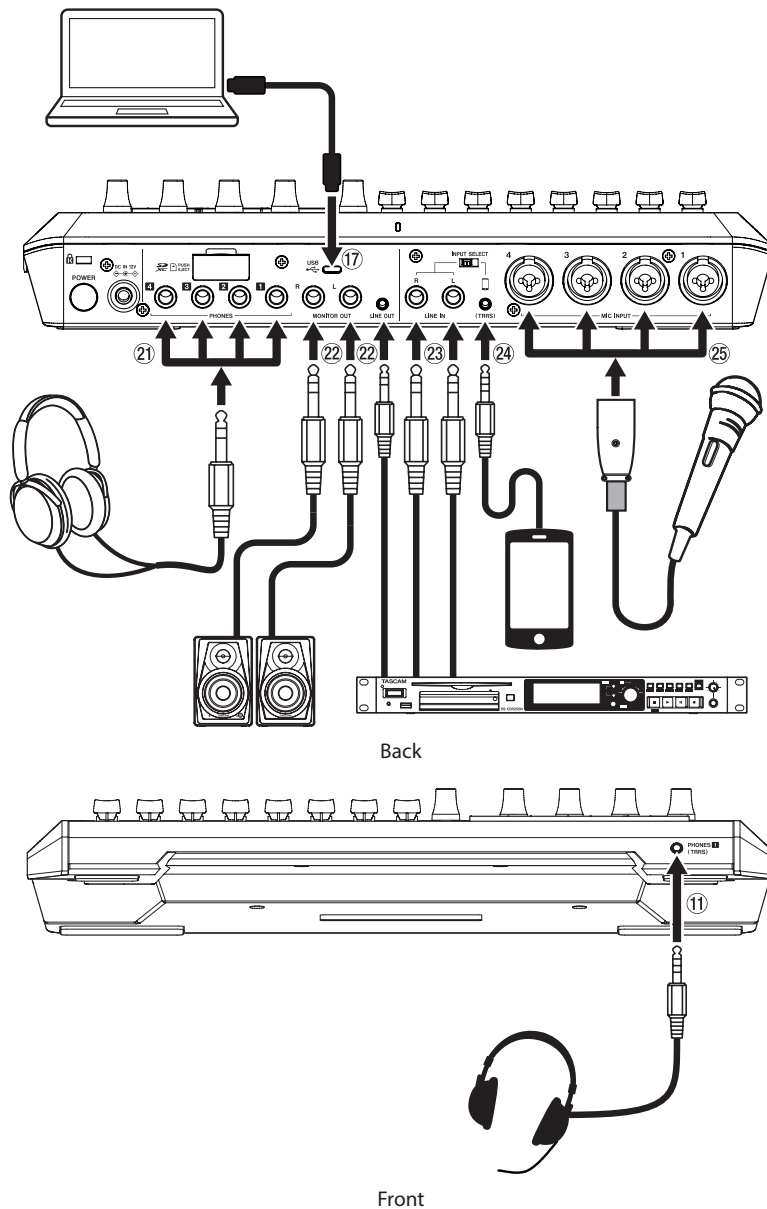

Note: For details about ①-⑫ in the illustration above, See "Top panel" on page 5 and See "Rear panel" on page 6.



## Connecting the power

Use the included AC adapter (PS-P1220E NUT) to connect a power supply to the unit as shown below.

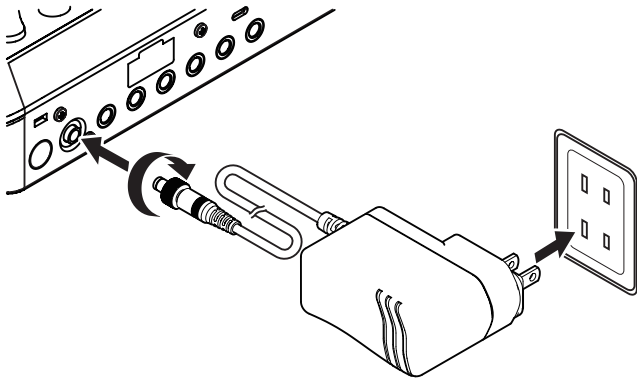

1. Connect the DC plug of the AC adapter to the DC IN 12V connector on the back of the unit.
2. Turn the nut on the DC plug to secure it to the DC IN 12V connector.
3. Connect the AC adapter to an outlet.

### CAUTION

Always connect the included AC adapter (PS-P1220E NUT), which is specified for use with this unit. Use of a different adapter could cause malfunction, fire or electric shock.

## Turning the power on and off

### Turning the power on

1. Press and hold the POWER button (19) on the back to turn the unit on.

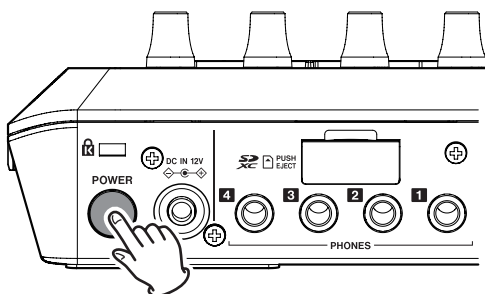

POWER button (19)

### NOTE

A tutorial that explains the unit simply will appear the first time it is turned on after purchase. Then, the Others Screen will open on the touchscreen so that language and Date/Time settings can be made. (For language, date and time setting instructions, see "Date/ Time Adjust" in See "Other settings" on page 36.)

2. When startup completes, the Home Screen will appear on the touchscreen as shown below.

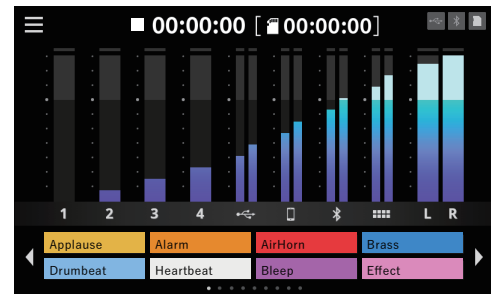

Home Screen

### Turning the power off

Press and hold the POWER button (19) to turn the unit off. When a pop-up message appears on the touchscreen to confirm turning the power off, release the POWER button.



Tap "Yes" to run the shutdown procedure and turn the unit off.

### NOTE

- The unit will save various settings before it turns off.
- This unit has an AUTO POWER OFF function that can automatically turn it off.  
For details about the AUTO POWER OFF function, see the corresponding section in See "AUTO POWER OFF" on page 37.

## Tutorial overview

- When the unit is turned on, a tutorial screen will open to explain the basics of operating the unit.
- If the tutorial is unnecessary, tap the x at the top right to close the screen.
- Put a check in the "Hide Tutorial" checkbox in the final tutorial screen to prevent it from being shown in the future.\*  
\*This tutorial will be shown again if the unit is restored to its default settings. (To restore the unit to its default settings, in See "Other settings" on page 36.)



## 3 - Preparation

### Connecting microphones

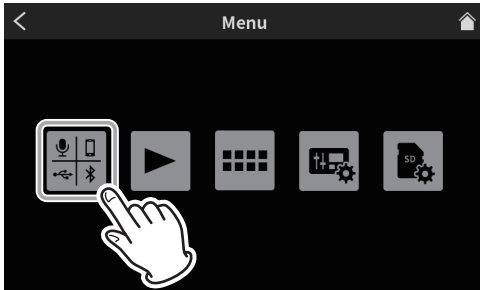
1. Connect mics to the MIC INPUT 1–4 jacks on the back. Point the mics at the sound sources and place the unit in a stable location where there is little vibration.
2. Select the mic type.  
Tap the  input icon on the Menu Screen to open the Input Screen



Menu Screen

3. Tap a  –  mic icon to select that mic.

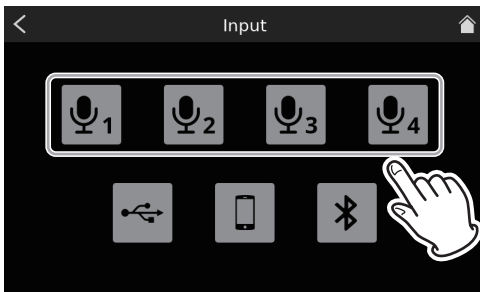

Input Screen

4. This will open the Level Screen. Tap the Condenser or Dynamic (default) button to set the mic type.  
(The following illustration example shows “Mic1”)

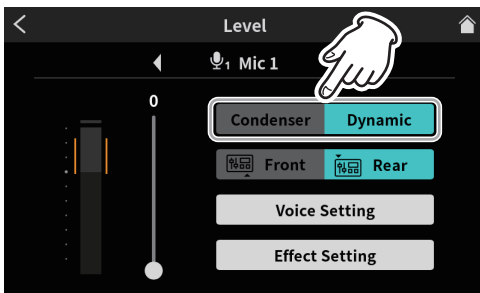

Level Screen

- Only the Mic 1 screen has “Front” and “Rear” options. After selecting the mic type, tap the  home icon at the top right to return to the Home Screen.  
If “Condenser” is selected as the mic setting, +48V power will be supplied to that mic input and a red dot will be shown next to that channel number on the Home Screen.

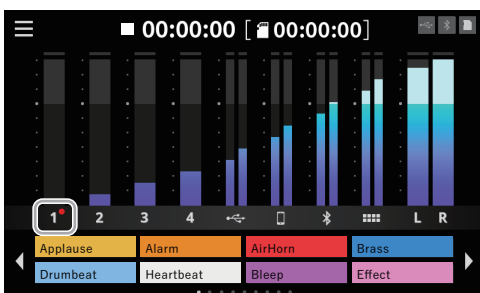

Home Screen

### CAUTION

- Do not connect mics that are compatible with plug-in power. Doing so could cause damage.
- When “Condenser” is selected as the mic setting for a MIC INPUT jack, phantom power (+48V) will be turned on. Doing so could damage dynamic mics if they are connected.  
Be careful when connecting mics and selecting mic types.
- If “Condenser” has been selected, the following message will appear the next time the unit is turned on.

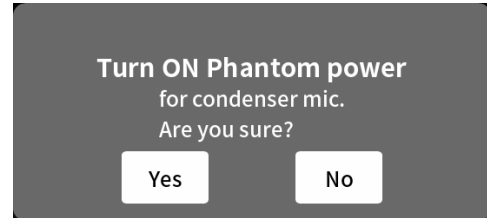

Tap “Yes” to supply phantom power (+48V) to mic inputs that have been set to “Condenser”.

Tap “No” to change the settings of all mic inputs to “Dynamic”.

### Connecting headphones

Connect headphones to the PHONES **1** – **4** jacks (21) on the back.

### CAUTION

Before connecting headphones, minimize the volumes with the PHONES **1** – **4** knobs (6). Failure to do so might cause sudden loud noises from the headphones, which could harm hearing or result in other trouble.

### Connecting headsets (switching Mic 1 input)

Connect a headset to the PHONES (TRRS) **1** jack (11) on the front.

### CAUTION

Before connecting a headset, minimize the level of the PHONES **1** knob (6) on the top.

Failure to do so might cause sudden loud noises from the headset, which could harm hearing or result in other trouble.

### Using a headset mic

To use the headset mic input as channel 1, set the input to “Front” on the Mic 1 Level Screen.

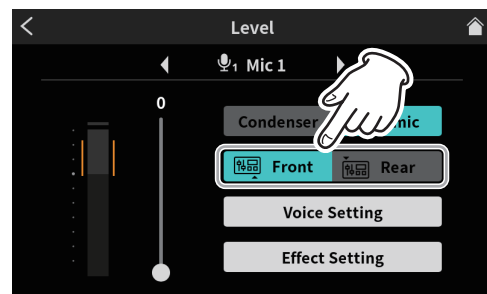

Level Screen

- To use the MIC INPUT 1 jack (25) on the back of the unit set the input to “Rear” (default) on the Mic 1 Level Screen.

### NOTE

Output volume could be reduced if both PHONES **1** jacks (21) and PHONES (TRRS) **1** jack (11) are used at the same time.

## Making USB connections

Using USB to connect a computer, smartphone or tablet makes the following possible.

- The SD card in this unit can be used as USB mass storage.
  - Audio can be input and output by using it as a USB audio device.
1. Connect the included USB cable to the USB port (17) on the back of this unit and to a computer, smartphone or tablet.
  2. When this unit confirms USB connection, the USB icon will appear at the top right of its Home Screen.

### NOTE

The unit should be connected using the included USB cable\* directly to the smartphone, tablet or computer, not through a USB hub.

\*When using a USB cable purchased elsewhere, use a high-quality cable (that has USB certification) of the shortest length possible. (See "USB cables" on page 4.)

## Connecting smartphones, media players and similar devices

Connect smartphones and other portable devices as well as media players and other audio devices to the LINE IN (TRRS) or LINE IN jacks on the back of the unit. Doing so allows input of these sound sources.



- Audio from a caller can be input by connecting a mobile phone or smartphone to the LINE IN (TRRS) jack of this unit. Likewise, audio from this unit can also be sent to the caller.

### NOTE

The Mix Minus function is always used on audio output through the LINE IN (TRRS) jack. This prevents the audio from callers being returned to them.

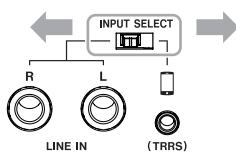
1. Set the INPUT SELECT switch (18) on the back of the unit according to the type of device being input.
  - When connecting a smartphone or other portable device to the LINE IN (TRRS) jack (24)
    - Set the INPUT SELECT switch (18) to  (TRRS)
  - When connecting a media player or other audio device to the LINE IN L/R jacks (23)
    - Set the INPUT SELECT switch (18) to LINE IN



2. Tap the  input icon on the Menu Screen to open the Input Screen. Then, tap the  smartphone icon to make voice settings, referring to See "Smartphone settings" on page 33.

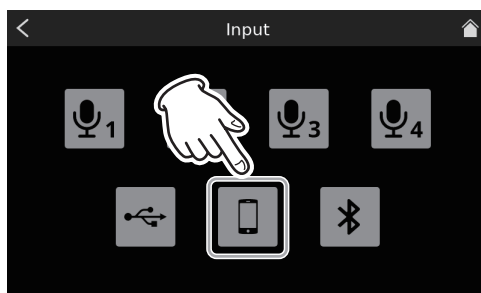

Input Screen

## Connecting recording devices and monitor speakers

Sound mixed or played back on this unit can be output through the MONITOR OUT L/R jacks (22) or LINE OUT jack (22) on its back to monitor speakers (powered monitor speakers or an amp and speaker system).

- MONITOR OUT L/R jacks (22)
  - For example, connect a recording device or powered monitor speakers that are compatible with standard 6.3mm (1/4") TRS jacks.
- LINE OUT jack (22)
  - For example, connect these to input connectors that support line input on a recording device.

Use the MONITOR OUT knob on the top to adjust the speaker volume.

### NOTE

If the volume cannot be adjusted with the MONITOR OUT knob (5), confirm that "Line Level Output" is set to "OFF" in the See "8-5-1. AUDIO" on page 36.

Volume cannot be adjusted when set to "ON".

### CAUTION

Before turning the power on and connecting monitor speakers, minimize the volume with the MONITOR OUT knob (5) on the top. Failure to do so might cause sudden loud noises, which could harm your hearing or result in other trouble.

## Connecting with Bluetooth devices

This unit has a built-in Bluetooth audio module. This enables input of sound played on computers and portable audio devices that support Bluetooth (A2DP) as well as output of sound from this unit to other Bluetooth devices.

Audio from a caller can be input by connecting a smartphone to this unit by Bluetooth. Likewise, audio from this unit can also be sent to the caller.

### NOTE

The Mix Minus function is always used on audio output to Bluetooth devices. This prevents the audio from callers being returned to them.

## Pairing

Follow the procedures below to enable pairing with a Bluetooth device.

### NOTE

Pairing also requires operation of the Bluetooth device.

Refer to the operation manual of the Bluetooth device being used for instructions about how to use it.

1. Tap the  input icon on the Menu Screen to open the Input Screen. Then, tap the  Bluetooth icon.

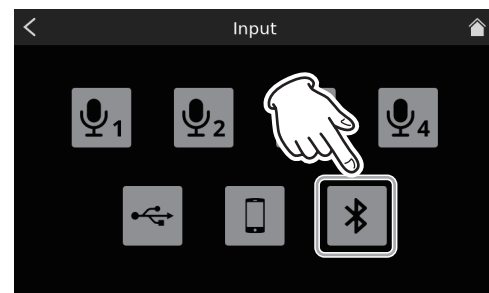

Input Screen

## 3 - Preparation

- This will open the Level Screen shown below. Tap the Pairing button to start pairing with the Bluetooth device.

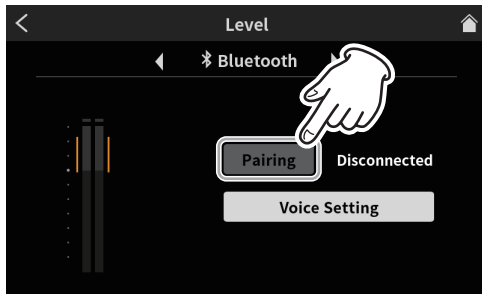

Level Screen

### NOTE

After the unit is turned on, the unit will automatically activate pairing mode for some time. Then, it will deactivate pairing mode.

- While searching for Bluetooth devices, the "Pairing" button will be highlighted and "Searching..." will appear in the message field to its right.

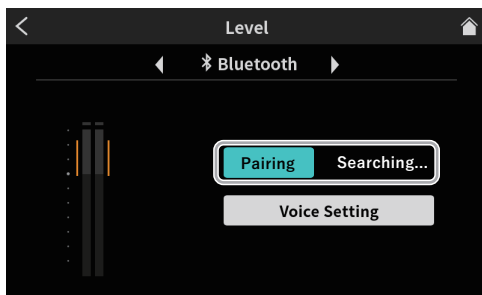

Level Screen

### NOTE

If connecting does not complete after some time, pairing mode will be deactivated automatically. To reactivate pairing mode, tap the "Pairing" button again.

- Select "TASCAM Mixcast" on the Bluetooth device to be paired.
- When Bluetooth connection is confirmed, "Connected" will appear in the message field, and the Bluetooth icon will appear at the top right of the Home Screen.
- After completing the Bluetooth connection, set Voice Setting options as explained in See "Bluetooth settings" on page 33.

## SD card insertion, removal and write protection

### Loading SD cards

This unit uses SD cards for recording and playback.

This unit can use SD cards that are Class 10 or higher and compatible with SD, SDHC or SDXC standards.

### NOTE

- This product does not include an SD card. Please purchase any that you need for your uses.
- We recommend using SD cards with capacities of at least 64 GB because multitrack recordings of all channel inputs use large amounts of space.
- A list of SD cards that have been confirmed for use with this unit can be found by accessing the TEAC Global Site (<https://teac-global.com>). Check the page for this product. You can also contact TASCAM customer support service.

- Open the SD card slot cover on the back and insert the card in the slot until it clicks into place.

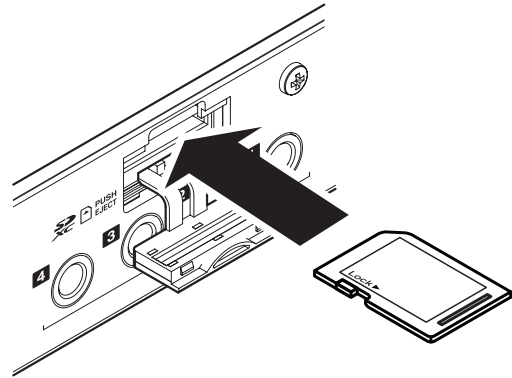

- Formatting is necessary if the pop-up message shown below appears on the touchscreen when an SD card is inserted.

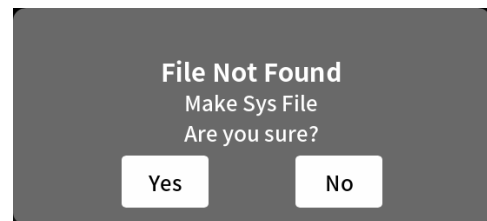

- Tap "Yes" to start formatting.
- When this unit confirms the SD card, the SD card icon will appear at the top right of the Home Screen.

### NOTE

SD cards formatted by this unit are optimized to improve performance during recording. Use this unit to format the SD cards to be used with it.

Errors might occur when recording with this unit using an SD card formatted by a computer or other device.

### Removing SD cards

First, turn the unit off or stop operation. Then, gently press the SD card in to eject it, and remove it

### CAUTION

Never remove an SD card when the unit is operating (including recording, playing back, or writing data to the SD card).

Doing so could cause proper recording to fail, data to be lost, and sudden loud noises from monitoring equipment, which might damage the equipment, harm hearing or cause other trouble.

- Open the SD card slot cover (16) on the back and push the card in gently until it comes out.
- Pull the SD card out.
- The SD card icon at the top right of the touchscreen will disappear.

### SD card write protection switches

SD cards have write-protection switches that prevent writing new data to them.

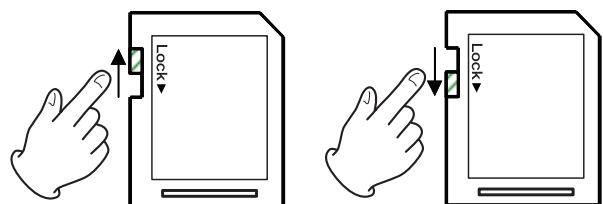

If you slide the write-protection switch to the "LOCK" position, writing will not be possible. Move the write-protection switch to the unlocked position in order to record, erase and otherwise edit data on the card.

## Adjusting input levels, audio characteristics and effects

Adjust each input before starting recordings for podcasts. Adjust the input levels, audio characteristics and effects to prevent distortion by input volumes that are too high or inaudible recording by levels that are too low.

### Lowering knob and fader volumes

Before starting input adjustments, set the following knobs and faders on this unit and the knobs and faders of the devices being connected to their lowest values.

- Lower channel faders (13).

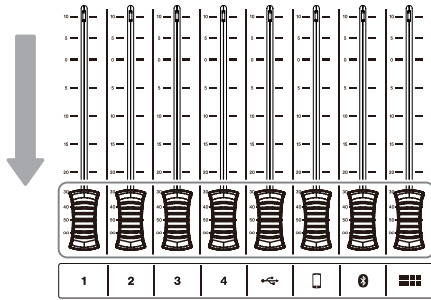

- Lower the MONITOR OUT (5) and PHONES 1 - 4 (6) knobs.

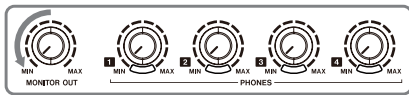

### Selecting mics for adjustment

1. Tap the menu icon on the Home Screen to open the Menu Screen.

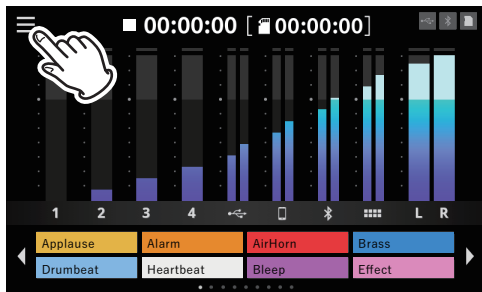

Home Screen

2. Tap the input icon.

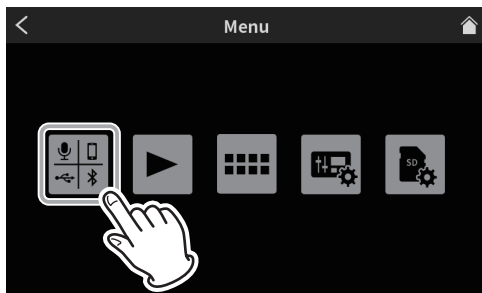

Menu Screen

3. On the Input Screen, select and tap the - mic icon for the mic input to adjust.

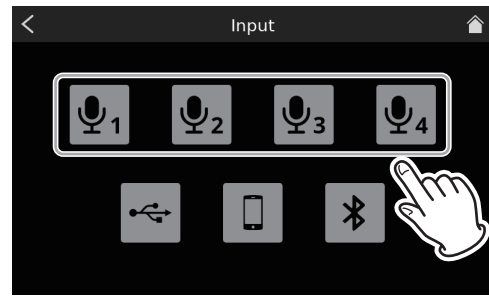

Input Screen

4. This opens the Level screen.

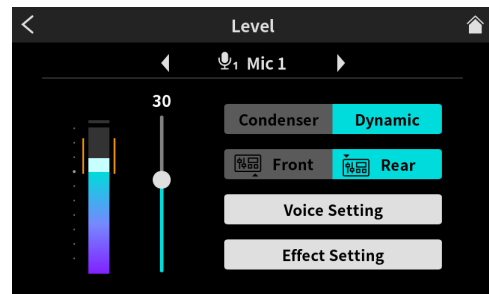

Level Screen

### Adjusting mic input levels

This is an example of procedures to adjust MIC INPUT 1.

1. While inputting sound through MIC INPUT 1, use the slider on the Level Screen to adjust the input level. Adjust so that the mic volume peak is in the orange range of the level meter to prevent input from being too high, causing distortion, or too low.

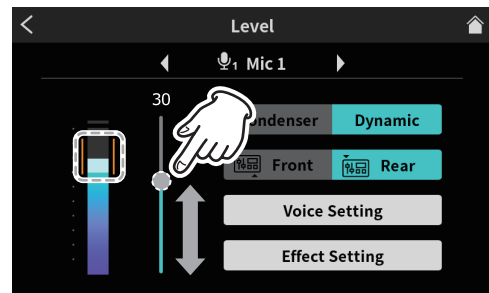

Level adjustment

2. Raise channel fader 1 so sound can be heard from the monitor speakers, and gradually turn up the MONITOR OUT (5) knob.

## 4 - Input Settings

### Adjusting mic input audio characteristics (Voice Setting)

After adjusting the volume peak, adjust the mic input audio characteristics as desired.

1. Tap the Voice Setting button.

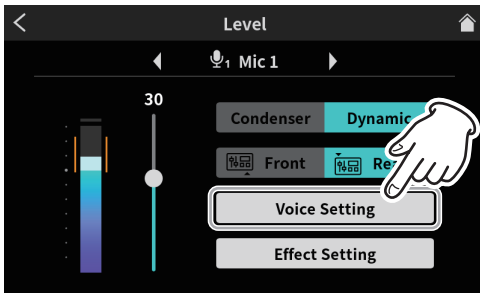

Voice Setting selection screen

2. This opens the first page of the Voice Setting Screen. The Voice Setting Screen has two pages.

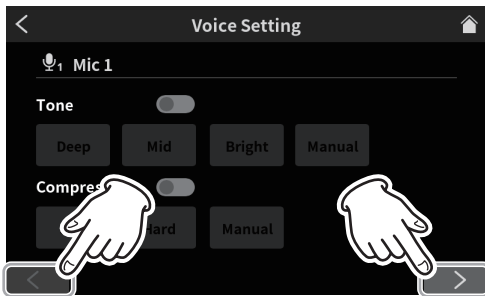

Voice Setting Screen page 1

Tap the [<] and [>] buttons at the bottom of the Voice Setting screen to switch between the two pages.

#### Adjusting the Tone

Tap the Tone switch to turn it on.

Three presets can be selected for Tone. Select Manual to make adjustments instead of using a preset.

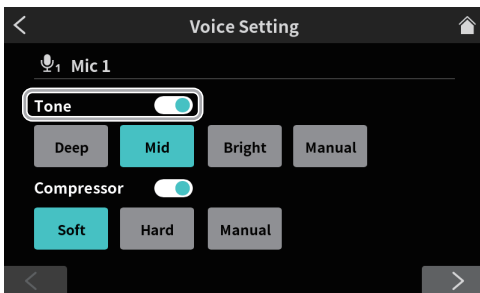

Voice Setting Screen page 1 (MIC INPUT 1 jack example)

Tapping one of the Tone setting icons selects it, highlighting it and turning the function on.

- Deep** This emphasizes low frequencies, making the tone deep.
- Mid (default)** This emphasizes middle frequencies.
- Bright** This emphasizes high frequencies, making the tone bright.
- Manual** This allows detailed tone adjustments. Tap the Manual icon to show the  settings icon.



Tap the  settings icon to open the Tone Manual Setting Screen. See "Tone Manual settings" on page 28.

### Adjusting the Compressor

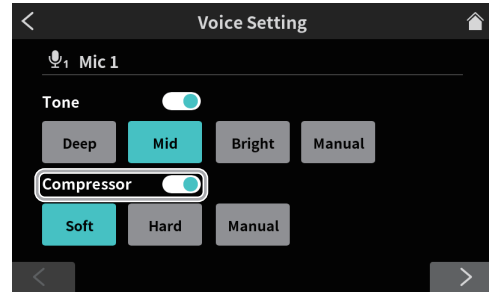

Voice Setting Screen page 1 (MIC INPUT 1 jack example)

Tap the Compressor switch to turn it on.

Two presets can be selected for the Compressor.

Select Manual to make adjustments instead of using a preset.

Tapping one of the Compressor setting icons selects it, highlighting it and turning the function on.

- Soft (default)** This naturally compresses loud parts of the sound.
- Hard** This greatly compresses everything to even the level.
- Manual** This allows detailed compressor adjustments. Tap the Manual icon to show the  settings icon.



Tap the  settings icon to open the Compressor Manual Setting Screen. See "Compressor Manual settings" on page 29.

3. When done making settings on the first page of the Voice Setting Screen, tap the [>] button at the bottom of the screen to open the second page.

### Adjusting the Processing

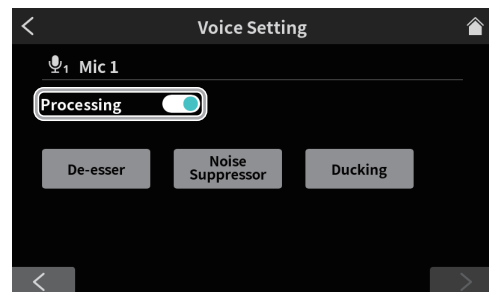

Voice Setting Screen page 2 (MIC INPUT 1 jack example)

Tap the Processing switch to turn it on.

Tapping one of the Processing setting icons selects it, highlighting it and turning the function on.

- De-esser** Reduce harsh high-frequency sibilant sounds.
- Noise Suppressor** Reduce background noise.
- Ducking\*** When a signal is input through MIC INPUT1, other signal levels will be lowered, making the sound from MIC INPUT1 stand out.

\*The Ducking setting can only be used with MIC INPUT 1.

- The  settings icons will be shown when processing setting functions are on.

Tap a  settings icon to enable detailed settings.

- See page 29 for details about De-esser manual settings.
- See page 30 for details about Noise Suppressor settings.
- See page 30 for details about Ducking manual settings.

## Adjusting mic input effects (Effect Setting)

The following adjustments can be made to change the mic input sound as desired.

The effect function is linked to the Sound Pad buttons (12).

By assigning an effect to a pad, its settings can be applied while the pad is pressed.

The effect can only be turned on for one channel.

### NOTE

The effect functions that can be assigned to Sound Pads (12) are "Reverb" and "Voice Changer".

1. Tap the Effect Setting button.

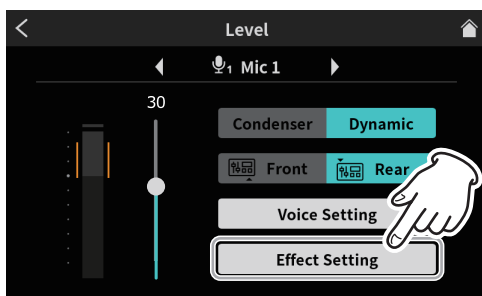

Effect Setting selection screen

A confirmation message will appear. Tap "OK" to open the Effect Setting Screen.

2. This opens the first page of the Effects Setting Screen. The Effect Setting Screen has two pages.

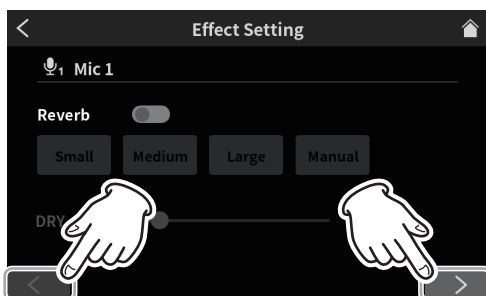

Effect Setting Screen page 1

Tap the [ $<$ ] and [ $>$ ] buttons at the bottom of the Effect Setting Screen to switch between the first and second pages.

The following settings can be made on the first page of the Effect Setting Screen.

### Reverb adjustment

Use the Reverb function to adjust the reverberations and make related settings.

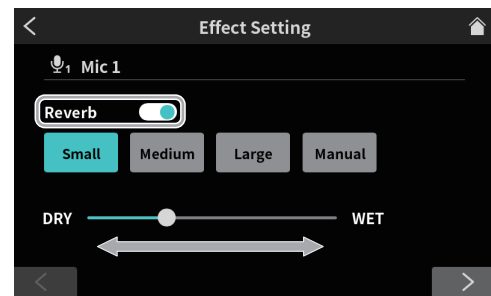

Effect Setting Screen page 1

A confirmation message will appear when the reverb switch is turned on. Tap "OK" to turn on the Reverb function.

- The following three presets can be selected for Reverb. Select Manual to make adjustments instead of using a preset.
- Tapping one of the Reverb setting icons selects it, highlighting it and activating that setting.

- Small** This is equivalent to the "Room" manual reverb setting and has the smallest amounts of reflections and reverb sound.
- Medium (default)** This is equivalent to the "Studio" manual reverb setting and has medium amounts of reflections and reverb sound.
- Large** This is equivalent to the "Hall" manual reverb setting and has the greatest amount of reflections and reverb sound.
- DRY/WET** Move the slider to adjust the amount of the reverb effect.
- Manual** This allows detailed reverb adjustments. Tap the Manual icon to show the  settings icon.



Tapping another icon will make the  settings icon disappear.

Tap the  settings icon to open the Reverb Manual Setting Screen. See "Reverb manual settings" on page 31.

3. When done making settings on the first page of the Effect Setting Screen, tap the [ $>$ ] button at the bottom of the screen to open the second page.

The following settings can be made on the second page of the Effect Setting Screen.

### Adjusting the Voice Changer

The Voice Changer function can make voices sound lower or higher by adjusting the pitch.

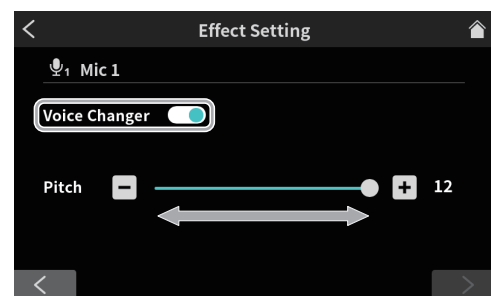

Effect Setting Screen page 2

Turn the Voice Changer switch on to enable the Voice Changer function.

Move the slider or use the [ $-$ ] and [ $+$ ] buttons to adjust the pitch.

## 4 - Input Settings

4. This completes mic input settings for MIC INPUT1.
5. Next, make mic input settings for MIC INPUT2–4 in the same way as for MIC INPUT 1.

As necessary, tap the  input icon on the Menu Screen to open the Input Screen, and make the following input adjustments and settings.

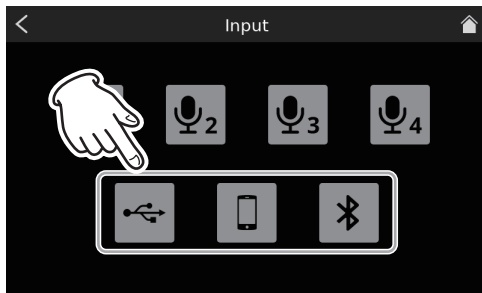

Input Screen

- USB settings (see page 32)
- Smartphone settings (see page 33)
- Bluetooth settings (see page 33)



# 5 - Recording and Playback

## Recording

Start podcast recording after completing adjusting the input levels, audio characteristics and effects for each channel.

1. Load an SD card.
2. If effect sounds and background music (BGM) assigned to Sound Pads will be used while recording, on the Home Screen switch to the Sound Pad bank that has the necessary sounds before starting recording.
  - See "Adding effect sounds while recording" on page 18 for procedures to switch banks.
  - See "Sound Pad overview" on page 23 for procedures to add effect sounds and BGM to Sound Pads.

### NOTE

The Sound Pad bank cannot be changed while recording.

3. After preparation is complete, press the REC/PAUSE [●] button (9) on the unit to start recording.

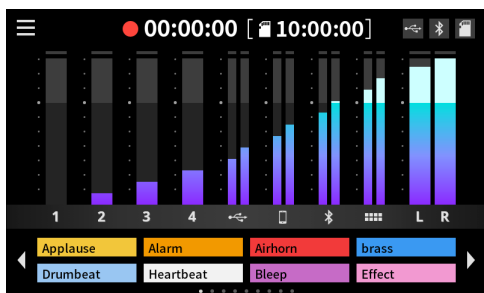

Recording Home Screen

- Press the REC/PAUSE [●] button (9) while recording to pause recording.  
(The ●|| paused icon will appear when recording is paused.)

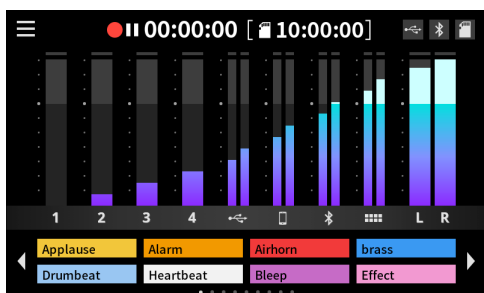

Screen when recording is paused

4. To stop recording, press the STOP [■] button (8) when recording or paused.



The following message will appear.

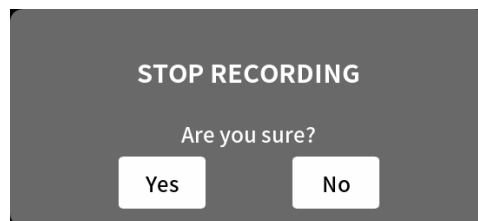

5. Tap "Yes" to stop recording.

### NOTE

Recording will continue while the message is shown until "Yes" is tapped.

6. After recording stops, the RENAME Screen will open. The provisional name will be shown. Use the screen keyboard as necessary to input a new name for the podcast, and tap "OK".



RENAME Screen

### NOTE

- Tap "Aa" on the keyboard to switch between uppercase letters, lowercase letters, and numbers and symbols.
- If wrong characters are input, tap "Del" to delete one character at a time.
- Podcast files are saved in the PODCAST folder on the SD card.
- Saved files are named with the podcast name and "\_01.wav" added to the end.  
If the file size exceeds 4 GB, additional files will be created and named in order with "\_02.wav" and "\_03.wav" added to their ends.

### NOTE

- When SD Multi Record is ON, recording to files will occur with the following channel order.

Channels 1/2/3/4	MIC INPUT 1-4 input signals
Channels 5/6	USB input signals
Channels 7/8	LINE IN L/R or LINE IN (TRRS) input signals
Channels 9/10	Bluetooth input signals
Channels 11/12	Sound pad playback sounds
Channels 13/14	Stereo mix

- When SD Multi Record is off, only the stereo mix will be recorded.  
(See "MULTITRACK" on page 36.)

## 5 - Recording and Playback

### Adding effect sounds while recording

Effect sounds and BGM assigned to Sound Pads can be added while recording.

1. On the Home Screen, use the ◀ and ▶ icons to switch banks to open the one with the Sound Pads that have the necessary sounds.

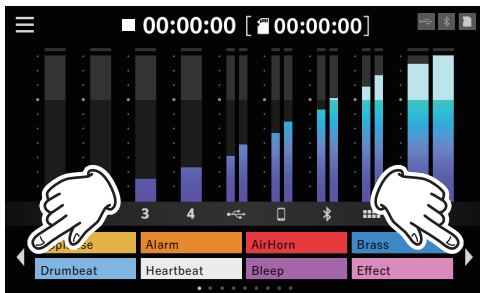

Home Screen (switching banks)

2. After switching banks, press Sound Pads (12) to play the sounds assigned to them.

#### NOTE

- Playing effect sounds and BGM while recording will cause those sounds to also be recorded.
- The bank cannot be changed while recording. Switch to the necessary bank before beginning recording.

### Adding marks while recording

Press the MARK button (7) while recording at positions where events occur to add marks at those points.

This is useful to check content if you want to change it after recording.



The necessary points can be found quickly when editing recorded content in the dedicated software or to overwrite it on the Advanced Screen opened from the PLAY Screen.

Added marks can be checked on the Advanced Screen during playback. (See "Checking added marks on the Advanced Screen" on page 20.)

#### NOTE

The maximum number of marks that can be added to a single podcast is 99.

### Playing recordings

This unit can play podcasts recorded on it.

1. Tap the ☰ menu icon on the Home Screen to open the Menu Screen.

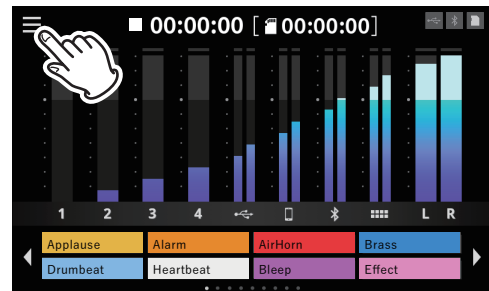

Home Screen

2. Tap the ▶ play icon.

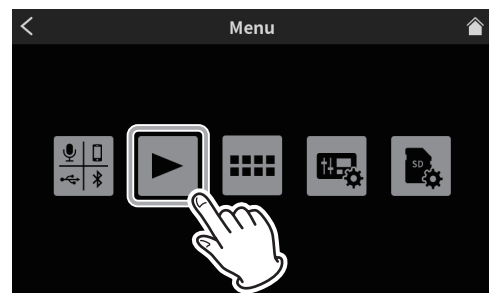

Menu Screen

This opens the podcast PLAY Screen.

3. Tap the podcast you want to play to select it.



PLAY Screen

The selected podcast will be highlighted.

4. Tap the ▶ play icon to start playback. Press the MARK button (7) while it is lit to add a mark at that point. (See "Adding marks during playback" on page 19.)

- During playback, the ► play icon will change to the || pause icon. Tap the || pause icon to pause playback.
  - When paused, it changes to the ► play icon. Tap the ► play icon again to resume playback.



Screen when stopped

- Press the STOP [■] button (8) when paused to set the playback starting position to the beginning of the podcast.
- Selecting a different podcast or opening any screen other than the PLAY Screen will stop playback of the podcast.

## Changing the names of podcasts

Podcast names can be changed using the following procedure.

- Tap the name of the podcast you want to change on the PLAY Screen to select it.

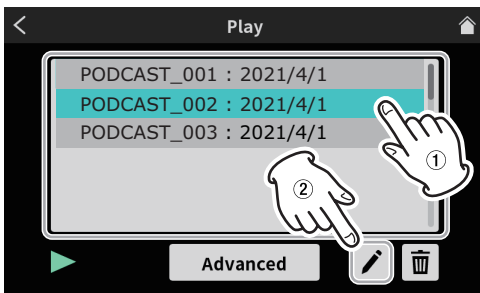

PLAY Screen

- The selected podcast will be highlighted.
- Tap the ✎ rename icon to open the RENAME Screen. Use the screen keyboard to input a new name for the podcast.

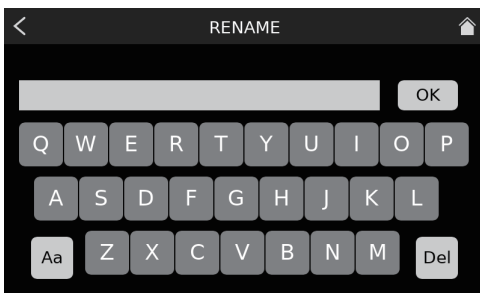

RENAME Screen

- Tap "Aa" on the keyboard to switch between uppercase letters, lowercase letters, and numbers and symbols.
  - If wrong characters are input, tap "Del" to delete one character at a time.
- After completing the podcast name change, tap "OK" on the screen keyboard to confirm it.

## Deleting podcasts

- Tap the name of the podcast you want to delete on the PLAY Screen to select it.



PLAY Screen

- Press the 🗑️ trash icon to open the following message.

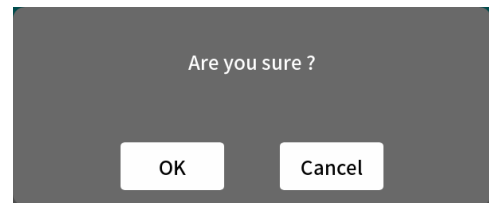

Tap "OK" to delete the podcast.

### ATTENTION

Deleted podcasts cannot be restored.

Be careful not to use this function mistakenly in order to avoid deleting important data.

## Adding marks during playback

By adding marks, points can be found quickly when editing recorded content in the dedicated software or overwriting on the Advanced Screen.

- Press the MARK button (7) during playback to add marks at positions where you want them.



- The following message will appear when marks are added.

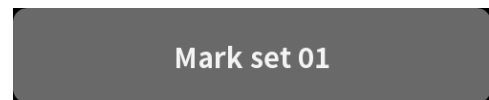

Added marks can be checked on the Advanced Screen.

## 5 - Recording and Playback

### Advanced playback functions

Using advanced playback functions, podcasts can be recorded over and checked. On the Playback Screen, tap the Advanced button.



PLAY Screen

3. The Advanced Screen will open.

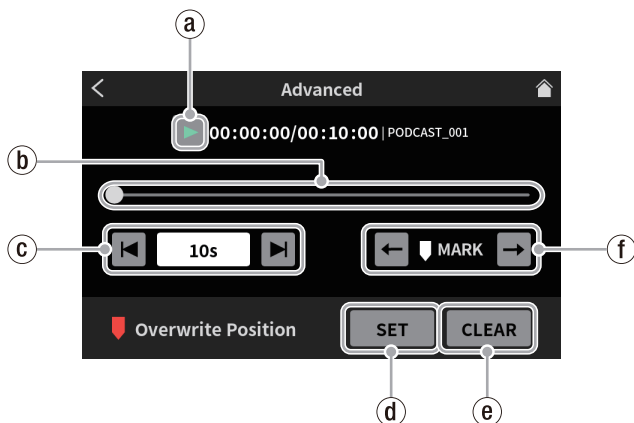

Advanced Screen

**a) Play icon**

Tap this to play the selected podcast. During playback, the ► play icon will change to the || pause icon.

**b) Timeline and slider**

The playback position can be changed as desired by moving the slider on the timeline.

**c) Time jumping controls**

Tap the time display field to show and select from the following forward/backward jump times.

- 1s, 5s, 10s (default), 30s

After selecting the jump time, tap the ◀ and ▶ icons to find the position where overwriting should start.

**d) SET button**

Tap this to move the mark (overwrite starting position) to the slider position.

**e) CLEAR button**

This clears the mark (overwrite starting position) shown by the SET button.

**f) Mark jump controls**

When playing a podcast that already has marks added to it, tap the ◀ and ▶ icons to move the slider directly to them on the timeline.

### Checking added marks on the Advanced Screen

Added marks can be checked on the Advanced Screen. Tap the Advanced button to open the Advanced Screen.



PLAY Screen

- If a podcast has marks added to it, they will be shown above the timeline.



Advanced Screen

- Tap the ◀ and ▶ jump icons to move the slider directly to marks on the timeline.

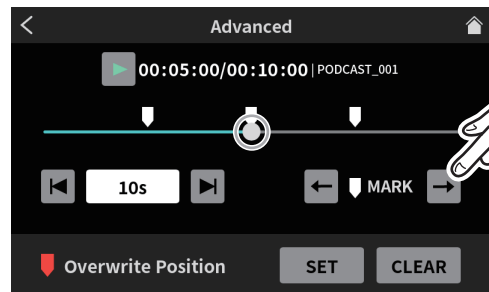

Advanced Screen

### Deleting added marks on the Advanced Screen

To delete a mark that has been added, when playback is stopped or paused, use the ◀ and ▶ mark jump icons to move the slider to the desired mark. Then, press the MARK button (⌚) to delete it

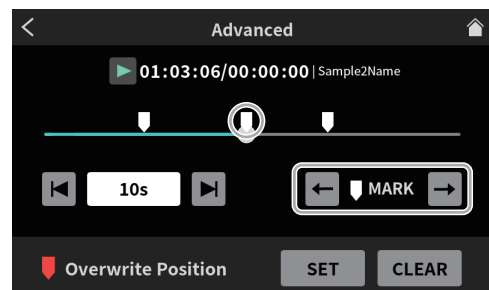

Advanced Screen

The following message will appear when marks are deleted.

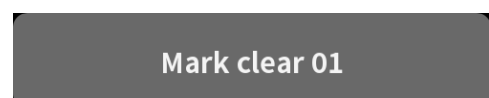

## Overwrite recording

A recorded podcast can be recorded over (overwritten) from a mark point added to it or any desired position using the advanced playback functions.

When overwrite recording is conducted, from the time where it starts, the existing audio will be replaced with the new recording.

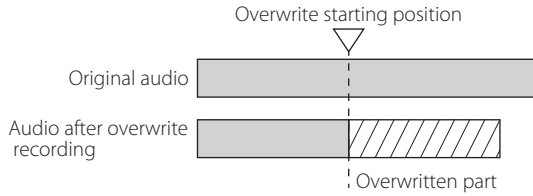

## Overwrite recording from an added mark

Select the podcast to overwrite on the PLAY Screen, and tap the Advanced button to open the Advanced Screen.

1. On the Advanced Screen, use the ← and → MARK jump controls to move the slider on the timeline to the point where you want overwrite recording to start. Then, tap the SET button.



Advanced Screen

This will set the recording starting position, which will be shown as the Overwrite Position mark above the timeline.

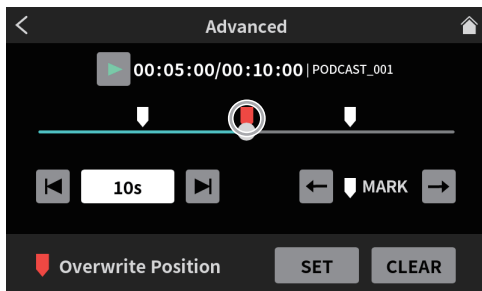

Advanced Screen

### NOTE

The overwrite recording starting position will be set after 00:00:01.

2. Press the REC [●] button (⑨) on the unit to start overwrite recording.
  - While overwriting, the Overwrite Recording Home Screen will be shown.

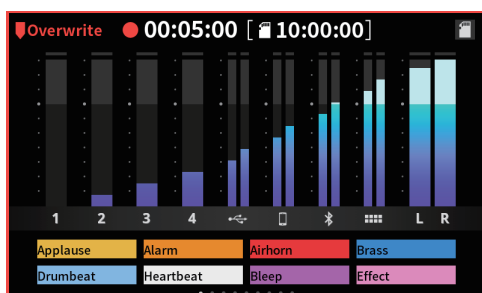

Overwrite Recording Home Screen

3. After recording completes, press the STOP [■] button (⑧). The following message will appear.

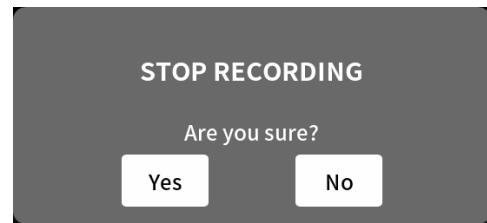

4. Tap "Yes" to stop recording and open the confirmation screen.



Advanced Screen

5. Tap the ► play icon on the confirmation screen to check the content of the overwritten recording.
  - If there are no issues, tap "OK".
  - Tap "Retry" if you want to redo overwrite recording. Since this will open the confirmation message in step 2, press the REC/PAUSE [●] button (⑨).  
Overwrite recording from the same position can be conducted again.
  - To cancel overwriting, tap "DISCARD".

## Using TALKBACK functions

By using the TALKBACK function, speaking (from the director) through Mic 1 can be output only to PHONES 2 - 4 (the participants) during podcast recording, for example.



TALKBACK

- To use the TALKBACK function, speak through Mic 1 while pressing the TALKBACK button (③).  
While the TALKBACK button (③) is being pressed, output is through the PHONES 2 - 4 jacks.  
Furthermore, unless the SOLO function is being used, it will also be output through the PHONES 1 and PHONES (TRRS) 1 jacks.
- While the TALKBACK button (③) is being pressed, the Mic 1 input audio will be muted and not recorded. It will not be output from the MONITOR OUT L/R or LINE OUT jacks (②).

# 6 - Using TASCAM Podcast Editor

This unit can be used with the functions of a 14-in/2-out USB audio interface by connecting it to a computer, smartphone or tablet by USB. In addition, the dedicated software\* can be used to add effect sounds, background music and other sounds to the Sound Pads as well as to edit podcasts recorded on the unit.

Note: See the TASCAM Podcast Editor operation manual for details about the software.

Some USB connection functions have limits with Android devices.

For details, see the TEAC Global Site (<http://teac-global.com/>).

## Sound settings when using with Windows OS

1. Open Settings > System > Sound, and open the Sound Control Panel.
2. After selecting the Recording tab, and selecting "Mic (Mixcast 4)", click "Set Default (S)".  
Confirm that a check (✓) is next to "Mic (Mixcast 4)", and click "Properties (P)".

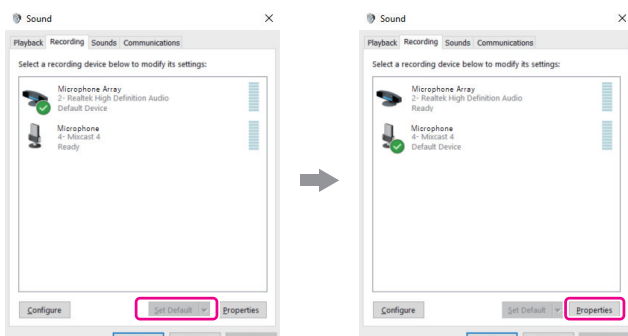

3. On the Mic Properties screen, open the Advanced tab and set the "Default Format" to "14 channel, 24 bit, 48000 Hz", and click the "OK" button.

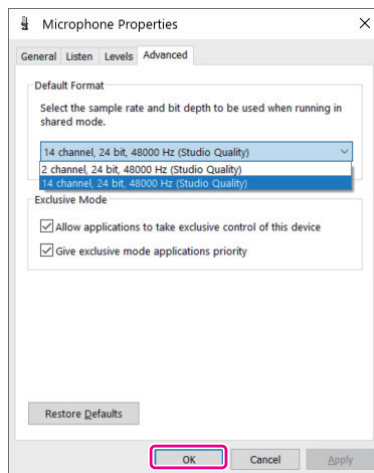

- To use TASCAM Podcast Editor or other software that supports multiple channels, select a 14 channel setting.
- Select a 2-channel setting when using OBS Studio or another application that supports 2-channel audio devices.

This completes Windows OS sound settings.

### NOTE

By installing a dedicated ASIO driver when using Windows OS, it can also be used with ordinary DAW software that supports ASIO. The dedicated ASIO driver can be downloaded from the website for this product.

## Using with Mac OS (audio settings)

1. Open the Audio MIDI Setup (🔊) app from the Applications folder.
2. Set "Mixcast 4" shown in the sidebar as the input/output (mic/speaker) device.

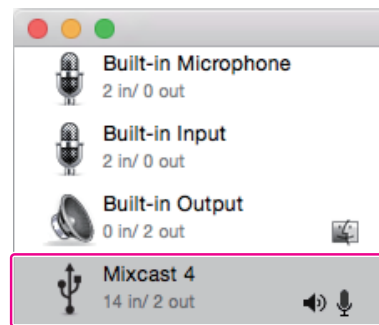

- Do not enable "Play Alerts and Sound Effects Through This Device".

3. Confirm that the "Input" setting is "14 ch" as shown in the illustration below.



This completes making audio settings for Mac OS.

## Using with iOS/iPadOS/Android devices

No sound or audio settings are necessary for connecting and using with iOS, iPadOS and Android devices.

## Data output by USB

Data output from this unit will be input to the computer, smartphone or tablet with the following channel order.

For Windows OS, Mac OS, iOS and iPadOS

Channels 1/2	Stereo mix
Channels 3/4/5/6	MIC INPUT 1-4 input signals
Channels 7/8	USB input signals
Channels 9/10	LINE IN L/R or LINE IN (TRRS) input signals
Channels 11/12	Bluetooth input signals
Channels 13/14	Sound pad playback sounds



Using an Android device

Channels 1/2	2 MIX
--------------	-------

## Sound Pad overview

- Effect sounds, background music (BGM) and other audio can be assigned to each of the Sound Pads (12) on top of the unit.
- Groups of sound source settings for pad buttons (1–8) are called “banks” in this document.
- This unit can switch between 9 banks (0–8), allowing a total of 72 different sounds to be played. Up to 8 sounds can be set for the pads in banks 1–8.
- Bank 0 is preset with sound sources included in the unit. Press the pads to play the sounds assigned to them. During recording, assigned sounds can be played and various effects can be applied to the recording.
- Using the dedicated software, sounds can be transferred to each pad. (See the TASCAM Podcast Editor operation manual for details about the software.)
- Use the Pad Settings on the Sound Pad Settings Screen to edit the function assignments of each pad (including color, play method and setting clearing). (See “8 PAD Settings” on page 23.)
- Using PAD Advanced on the Sound Pad Settings Screen, a “Bleep” sound or effect can be set. (See “0 PAD Advanced” on page 23.)  
\*The mic effect setting can be assigned to a sound pad and applied. (See “Adjusting mic input effects (Effect Setting)” on page 15.)
- Using PAD Rec in the Sound Pad settings, recorded sounds and effect sounds can be assigned to each pad. (See “9 PAD Rec” on page 23.)

## Explanation of Sound Pad Screen functions

Tap the  menu icon on the Home Screen to open the Menu Screen. Then, tap the  sound pad icon to open the Sound Pad Screen.

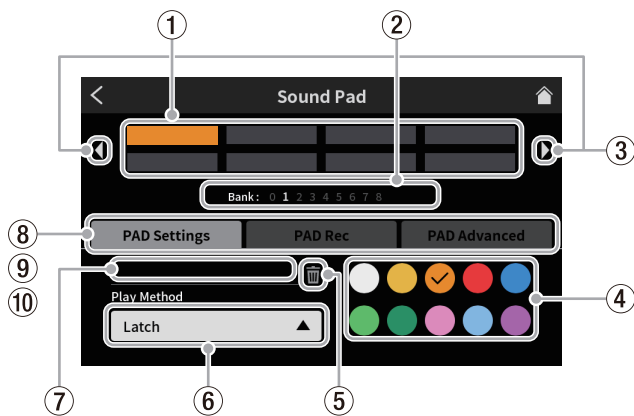

Sound Pad Screen

- 1 Pads**  
Tap a pad to check or change the function assigned to it. These are linked to the Sound Pad buttons on the unit (12).
- 2 Sound Pad Bank indicators**  
The number of the currently selected bank is highlighted.
- 3 Sound Pad Bank switch icons**  
Tap the ◀ icon to switch to the lower-numbered bank.  
Tap the ▶ icon to switch to the higher-numbered bank.

- 4 Pad color setting**  
The color of the selected pad can be changed.
- 5 Trash icon**  
Tap this icon to clear the settings and functions assigned to the selected pad.
- 6 Play Method**  
This shows how the effect sound or BGM of the selected pad will be output.  
The output mode can also be selected and changed.  
Tap the button and select one of the following play methods.
 

<b>Latch</b>	Press once to start playback, and once again to stop it. Press again to play from the beginning. If nothing is done, the file will play to its end before stopping.
<b>Pause</b>	Press once to start playback, and once again to pause. Press again to resume playback. If nothing is done, the file will play to its end before stopping.
<b>RePlay</b>	Press once to start playback. Press again to restart playback from the beginning. If nothing is done, the file will play to its end before stopping.
<b>One Shot</b>	Press once to start playback. The file will play to its end. To stop during playback, press and hold the pad button.
<b>Repeat</b>	Press once to start playback, and once again to stop it. Press again to play from the beginning. If nothing is done, the file will play repeatedly.
<b>Touch</b>	The sound will play only while the pad is being pressed.
- 7 Sound source file name**  
This shows the name of the sound source file shown on the pad.
- 8 PAD Settings**
  - The desired color can be selected and set with the pad color setting (4). These colors are also applied the Sound Pad buttons on the unit (12).
  - How effects and BGM are output can be set with the Play Method button (6).
- 9 PAD Rec**  
Effect sounds and BGM can be captured from each input signal. (See “Recording sounds and assigning them to Sound Pads” on page 25.)
- 10 PAD Advanced**  
Apply mic effect settings. (See “Assigning effects to Sound Pads” on page 24.)

# 7 - Using Sound Pads

## Playing Sound Pads

Sound Pads can be played on the Home Screen and MENU Screen.

**NOTE**

Sound Pads cannot be used during podcast playback on the PLAY Screen or Advanced Screen.

1. Press the Sound Pad buttons (12) to check their playback sounds

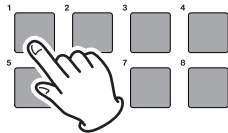

Pad playback

2. Use the channel faders (13) to adjust playback levels.

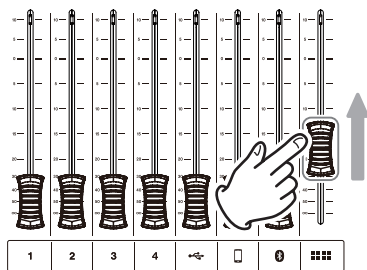

Fader adjustment

## Assigning effects to Sound Pads

Mic input sounds can be changed by effects assigned to Sound Pads. As an example, here we explain the procedure to add a sound that uses the voice changer effect function to Pad 1 of Bank 1.

1. Load an SD card.
2. Turn on the Voice Changer function on the mic Effect Setting Screen, and adjust the sound to the desired effect. This effect will be applied when the pad is pressed. (See "Adjusting mic input effects (Effect Setting)" on page 15.)
3. Open the PAD Settings page of the Sound Pad Screen and activate Bank 1.

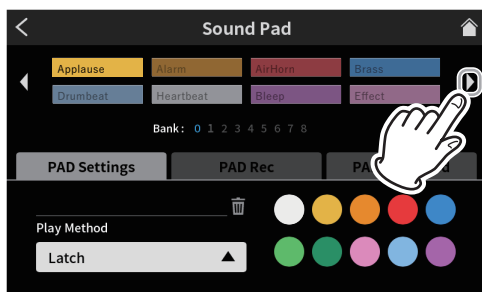

Sound Pad Screen PAD Settings page

**NOTE**

- Since Bank 0 is preset with the sound sources included in the unit, select Bank 1-8.
- If the pad in the bank you want to add the effect to already has an assignment, tap the trash icon and clear that pad, or tap a different pad that is empty.

4. Open the Bank 1 screen and tap Pad 1.

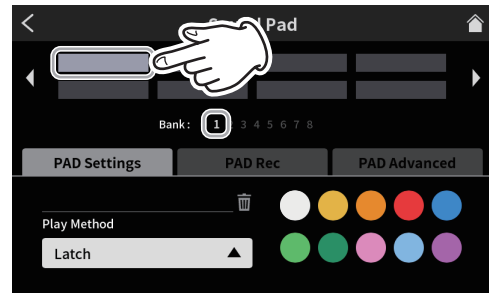

Sound Pad Screen PAD Settings page

The desired color can be set.

5. Next, tap "PAD Advanced" to show the advanced functions.

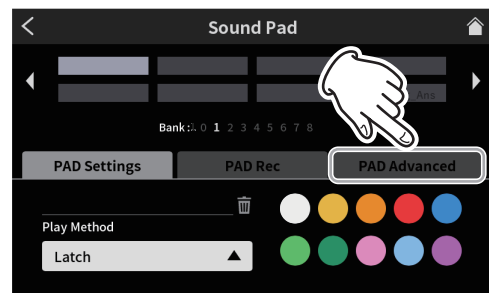

Sound Pad Screen PAD Settings page

6. When the advanced functions are shown, tap the round "Effect" button. "Effect" will be shown on Bank 1 Pad 1.

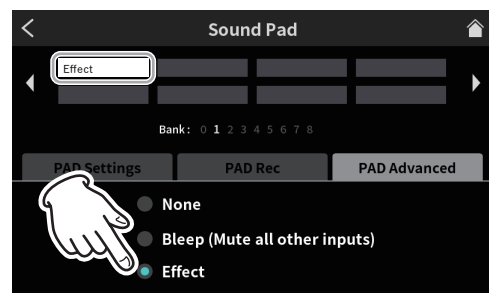

Advanced functions on Sound Pad Screen

This adds the effect function to Pad 1 of Bank 1.

**NOTE**

- The only playback method for the bleep sound is Touch.
- The only playback methods for the effect are Latch and Touch.

7. Next, tap "PAD Settings" to reopen the settings on the Sound Pad Screen.

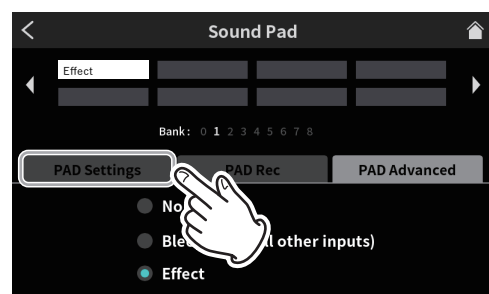

Advanced functions on Sound Pad Screen



- On the Pad Settings page, set the pad color as desired. Then, tap the Home icon at the top right to return to the Home Screen

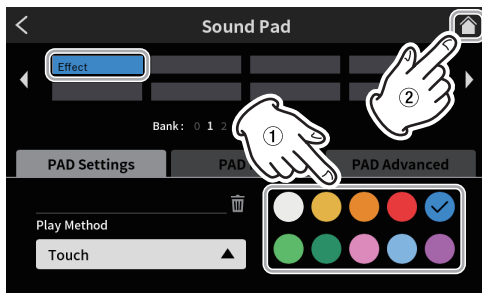

Sound Pad Screen PAD Settings page

- On the Home Screen, press Sound Pad (12) button 1. The effect will be applied to the mic input while the button is being pressed

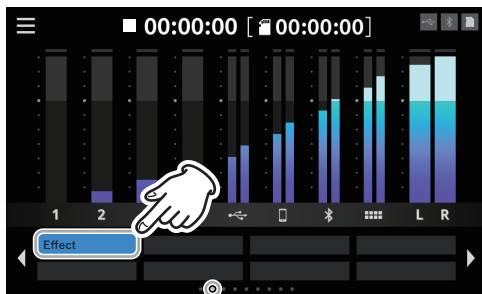

Home Screen

## Clearing Sound Pad effect functions

Use the following procedures to clear effect functions assigned to Sound Pads.

As an example, here we explain the procedure to remove an effect function assigned to Bank 1.

- Open the PAD Settings page of the Sound Pad Screen and activate Bank 1.

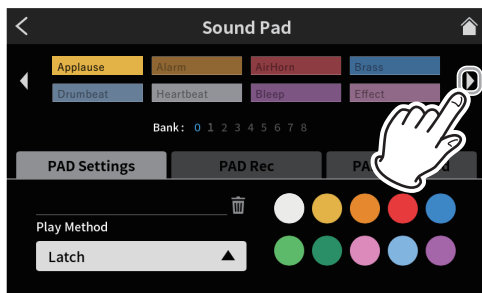

Sound Pad Screen PAD Settings page

- Open the Bank 1 screen and tap Pad 1.

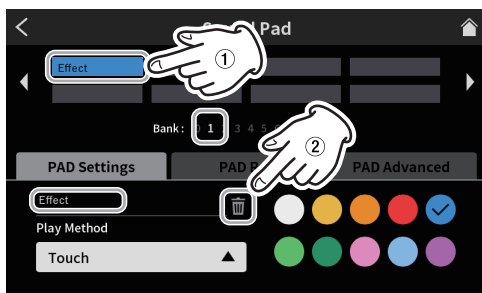

Sound Pad Screen PAD Settings page

- “Effect” is shown in the audio source file name field.
- Tap the garbage icon to clear the assigned effect function.

## Recording sounds and assigning them to Sound Pads

Sound Pad audio sources can be recorded by this unit.  
(The stereo mix of the unit is recorded.)

As an example, here we explain the procedure for recording and adding a sound to Pad 1 of Bank 1.

- Load an SD card.
- Adjust the faders and other controls so you can hear the sound mix that you want to record to the pad.
- Open the PAD Settings page of the Sound Pad Screen and activate Bank 1.

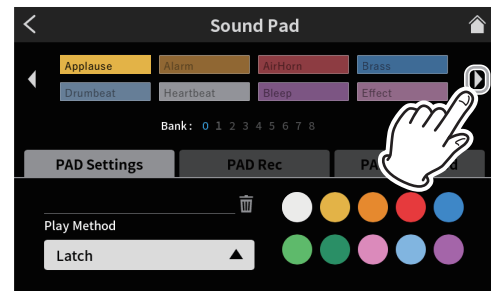

Sound Pad Screen PAD Settings page

- When the Bank 1 screen is open, tap Pad 1.

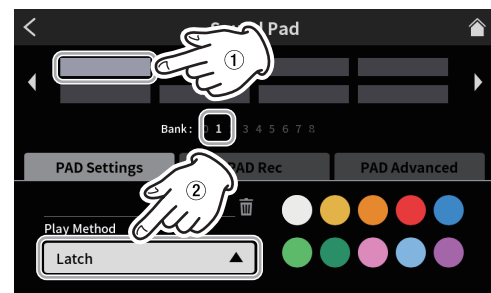

Sound Pad Screen PAD Settings page

- The desired color can be set.
- As necessary, select the Play Method on the Sound Pad Screen to set how it plays back.

- Next, tap “PAD Rec” to show the pad recording control.

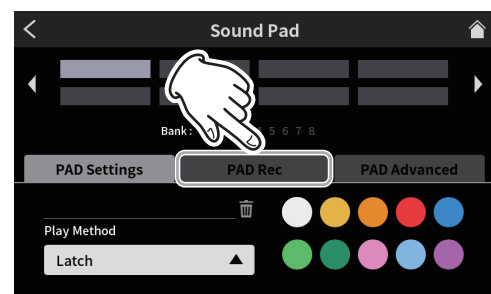

Sound Pad Screen PAD Settings page

## 7 - Using Sound Pads

6. Tap the "● Rec Start" button to start recording.

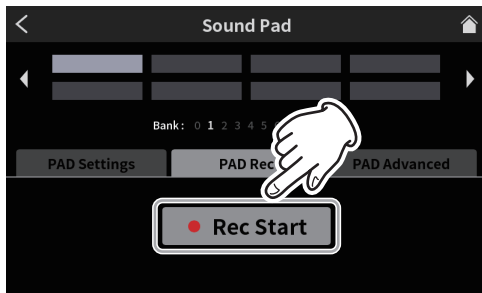

Sound Pad Screen ready to record

7. While recording, the button becomes "■ Rec Stop".

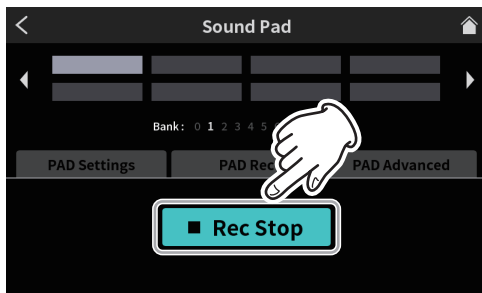

Sound Pad Screen ready to stop recording

8. Tap the "■ Rec Stop" button to stop recording.  
 9. Next, the RENAME Screen will open. The provisional name will be shown. Use the screen keyboard as necessary to input a new name.

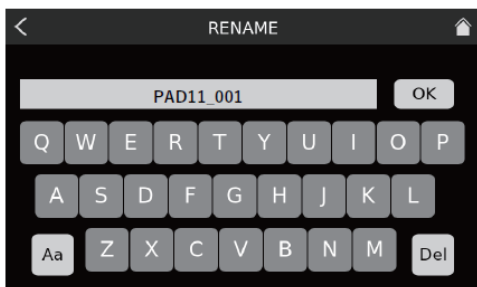

RENAME Screen

10. When complete, tap "OK" on the screen keyboard to confirm.  
 11. "PAD11\_001" will be assigned to Bank 1 Pad 1, and the Sound Pad Screen will reopen with PAD Rec activated.

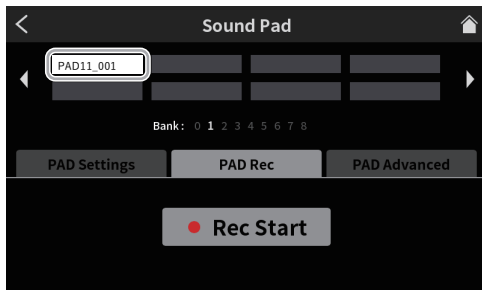

Sound Pad Screen ready to record

This completes assigning the recorded sound to Pad 1 of Bank 1.

12. Next, tap "PAD Settings" to reopen the settings on the Sound Pad Screen.

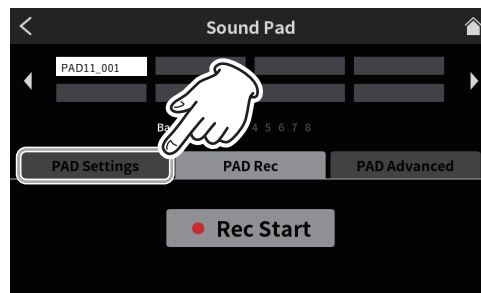

Sound Pad Screen ready to record

13. On the Pad Settings page, set the pad color as desired. Then, tap the Home icon at the top right to return to the Home Screen

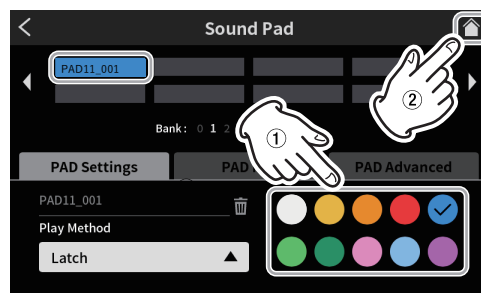

Sound Pad Screen PAD Settings page

14. On the Home Screen, press Sound Pad (Ⓜ) button 1 to play the sound recorded using the Sound Pad Screen recording function.

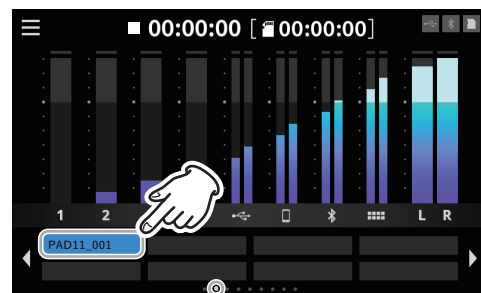

Home Screen

### NOTE

If the playback sound cannot be heard, adjust the Sound Pad fader.

# 8 - Touchscreen Functions

## 8-1. Menu Screen

Tap the Menu icon on the Home Screen to open the Menu Screen. Tap the icons on this screen to access the operations and settings of various functions.

1. Tap the  Menu icon on the Home Screen to open the Menu Screen.

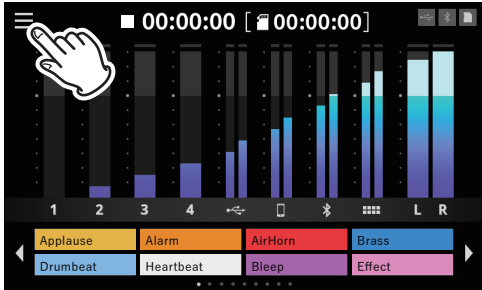





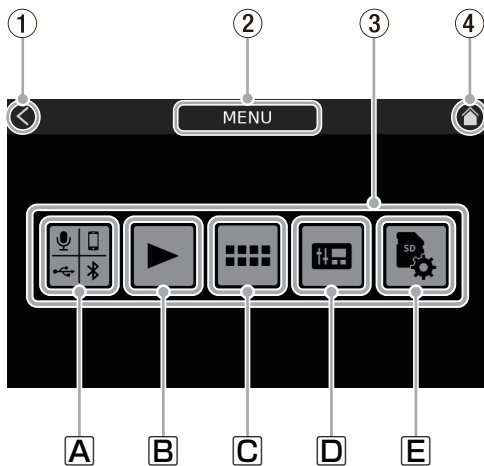

Home Screen

2. This opens the Menu Screen.



Menu Screen

- 1 < icon  
Tap this icon to return to the screen that was open before this one.
- 2 **Function name**  
This shows the function name of the screen being shown.
- 3 **Function icons**
  - A **Inputs**   
This opens the Input Screen (page 27).
  - B **Playback**   
This opens the podcast PLAY Screen (page 33).
  - C **Sound Pads**   
This opens the Sound Pad Settings Screen (page 34).
  - D **Hardware Settings**   
This opens the Hardware Settings Screen for the unit (page 35).
  - E **SD Settings**   
This opens the settings screen for SD cards (page 37).
- 4 **Home icon**   
Tap this icon to open the Home Screen.

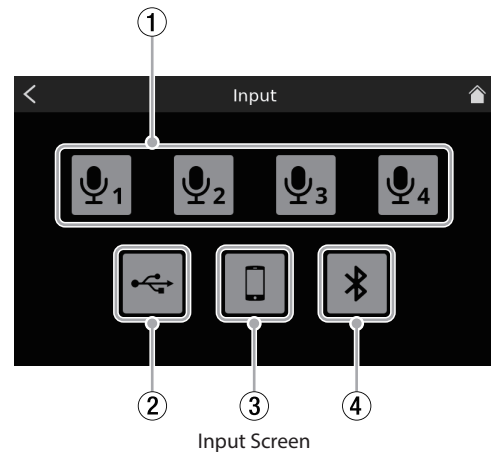

## 8-2. Input selection

Tap the  Input icon to open the Input Screen.



- 1 **Mic settings** (page 27)
- 2 **USB settings** (page 32)
- 3 **Smartphone settings** (page 33)
- 4 **Bluetooth settings** (page 33)

### 8-2-1. Mic settings

Tap Mic icon  -  to open the Level Screen. (This is an example of procedures to adjust MIC INPUT 1.)

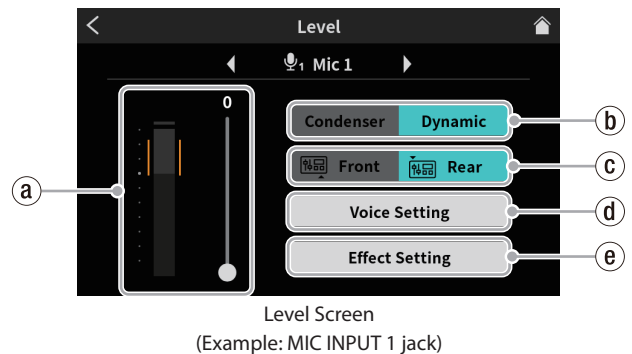

- a **Mic input level** (page 27)
- b **Condenser/Dynamic (mic type) selection** (page 27)
- c **Front/Rear input switch (MIC INPUT1 only)** (page 28)
- d **Voice Setting** (page 28)
- e **Effect Setting** (page 30)

#### 8-2-1-1. Mic input level

Use the slider to adjust the level. (Adjust the mic volume so that it is not too high or low and the volume peak stays in the orange range on the level meter.)

#### 8-2-1-2. Condenser/Dynamic (mic type) selection

Set the types of mics connected to MIC INPUT 1–4 jacks (25) to “Dynamic” (default) or “Condenser”. When “Condenser” is selected, +48V power is provided to the MIC input jack of the selected channel.

#### NOTE

Red dots will be shown on the Home Screen next to the labels (9) for channel numbers (1–4) of mic inputs set to “Condenser”.

Continued on the next page →

## 8 - Touchscreen Functions

### ⚠ CAUTION

When "Condenser" is selected, +48V power is provided to that MIC input. Before disconnecting a condenser mic, change the setting to "Dynamic" to turn +48V power off.

(If a dynamic mic is connected to a MIC INPUT 1-4 jack (25) that is set to "Condenser", it could be damaged.)

### 8-2-1-3. Front/Rear input switch (MIC INPUT1 only)

Select "Front" to use the mic input signal of a headset connected to the PHONES (TRRS) 1 jack (11) as the channel 1 input. (This does not apply to MIC INPUT 2-4.)

Select "Rear" (default) to switch to the MIC INPUT1 jack (25).

### 8-2-1-4. Voice Setting

The Voice Setting Screen has two pages.

Tapping Voice Setting opens the first page of the Voice Setting Screen.

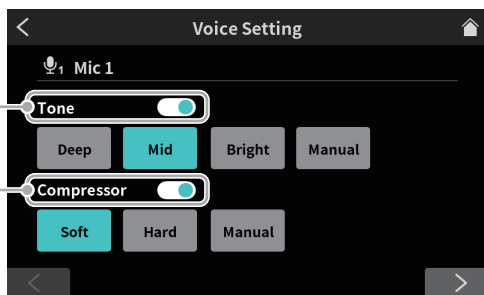

Voice Setting Screen page 1

Tap the > button at the bottom of the Voice Setting Screen to switch to the second page.

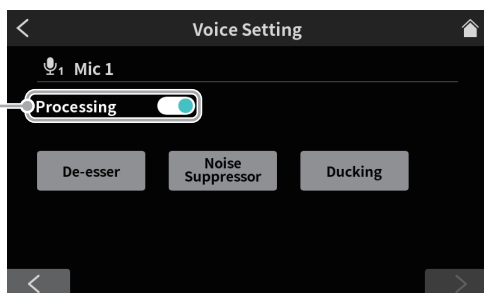



Voice Setting Screen page 2 (MIC INPUT 1 jack example)

### 1 Tone switch

Tap this to enable the Tone function, and select one of the following tone settings.

- Deep** This emphasizes low frequencies, making the tone deep.
- Mid** This emphasizes middle frequencies.
- Bright** This emphasizes high frequencies, making the tone bright.
- Manual** This allows detailed tone adjustments. Tap this to enable manual tone settings and show the  Tone Manual Setting icon. \*

- Tapping another icon will make the  settings icon disappear.

Tap the  settings icon to open the Tone Manual Setting Screen (page 28).

### 2 Compressor switch

Tap this to enable the Compressor function, and select one of the following compressor settings.

- Soft** This naturally compresses loud parts of the sound.
- Hard** This greatly compresses everything to even the level.
- Manual** This allows detailed compressor adjustments. Tap this to enable manual compressor settings and show the  Compressor Manual Setting icon. \*



Tapping another icon will make the  settings icon disappear.

\*Tap the  settings icon to open the Compressor Manual Setting Screen (page 29).

### 3 Processing switch

Tap to select one of the following Processing settings.

- De-esser** Tap this to enable the De-esser and show the  setting icon. \*\*



- Tapping the icon again will make the  setting icon disappear.

- Noise Suppressor** Reduce background noise. Tap this to enable the Noise Suppressor and show the  setting icon. \*\*

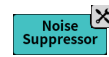

- Tapping the icon again will make the  setting icon disappear.

- Ducking\*** When a signal is input through MIC INPUT1, other signal levels will be lowered, making the sound from MIC INPUT1 stand out. Tap this to enable ducking and show the  setting icon. \*\*



- Tapping the icon again will make the  setting icon disappear.

\*The ducking function can only be used with MIC INPUT 1. It is not available for MIC INPUT2-4.

\*\*Use the  setting icons to access detailed adjustments. Tap them to open the following screens.

- De-esser Manual Setting Screen (page 29)
- Noise Suppressor Setting Screen (page 30)
- Ducking Manual Setting Screen (page 30)

### Tone Manual settings

The Tone Manual Setting Screen has two pages.

(Tap the [>] button at the bottom of the Tone Manual Setting Screen to switch to the second page (Exciter).)

This first page of the Tone Manual Setting Screen is shown first.

- Tone Manual Setting Screen page 1

On the first page of the Tone Manual Setting Screen, the volumes of the high and low frequencies in the input sound can be adjusted (equalization).

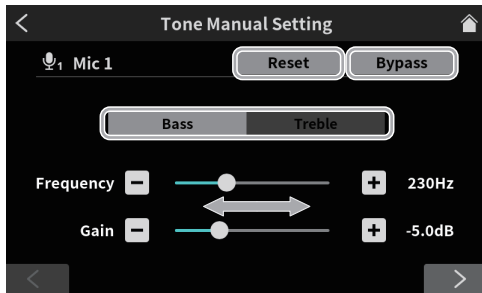

Tone Manual Setting Screen page 1

- Bass (low-frequency)/treble (high-frequency) adjustment switches  
Tap these to switch between high and low frequency adjustment screens.

- Reset  
Tap this to restore changed settings to default values.
- Bypass  
Tap to bypass Tone adjustments.

Move the slider or tap the – and + buttons to adjust the following values.

- Frequency  
This sets the boundary for high or low frequencies. For bass, the volume of sound lower than this frequency can be adjusted. For treble, the volume of sound higher than this frequency can be adjusted.

- Gain  
Use this knob to adjust the volume of the high or low frequencies.

- Tone Manual Setting Screen page 2 (Exciter)  
The Exciter can be adjusted on Tone Manual Setting Screen page 2. The exciter emphasizes sounds higher than the set high-frequency.

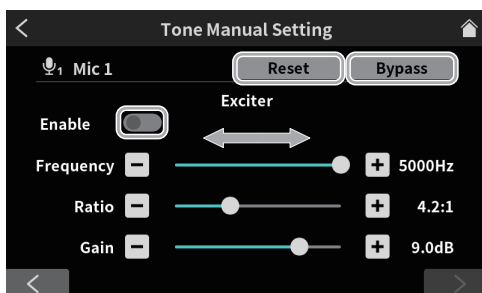

Tone Manual Setting Screen page 2 (Exciter)

- Reset  
Tap this to restore changed settings to default values.
- Bypass  
Tap to bypass the Exciter.
- Enable switch  
Tap this to enable the Exciter. The Exciter operates using the settings made on Tone Manual Setting Screen page 2.

Move the slider or tap the – and + buttons to adjust the following values.

- Frequency  
This sets the high frequency range to emphasize. Sounds higher than this frequency will be emphasized.
- Ratio  
This adjusts the amount that high frequencies are emphasized.

- Gain  
This adjusts the volume of high-frequency sounds.

### Compressor Manual settings

When the input volume exceeds the threshold level, this function compresses the volume variation range, reducing volume differences.

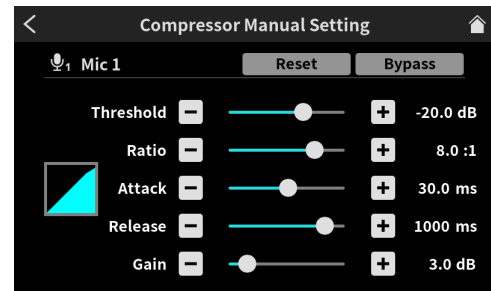

Compressor Manual Setting Screen

- Reset  
Tap this to restore changed settings to default values.
- Bypass  
Tap to bypass compressor adjustments.

Move the slider or tap the – and + buttons to adjust the following values.

- Threshold  
This sets the level that will cause the compressor to start.
- Ratio  
This sets the compression ratio for the input volume.
- Attack  
This sets the time until the compression reaches the compression ratio setting after the input volume exceeds the threshold.
- Release  
This sets the amount of time until the compression stops and the sound returns to its uncompressed level after the input sound goes below the threshold level.
- Gain  
This sets the amount of output sound amplification. When the volume is compressed, the output level becomes lower than the input level. By using the Gain setting to amplify the output signal, the level can be restored to close to the input level.

### De-esser manual settings (mic input)

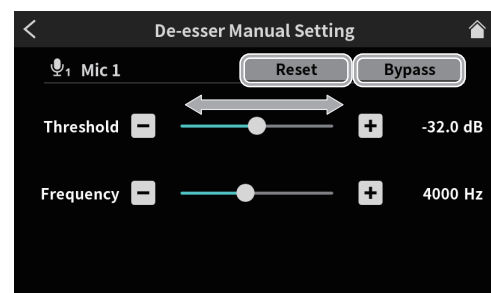

De-esser Manual Setting Screen

- Reset  
Tap this to restore changed settings to default values.
- Bypass  
Tap to bypass the de-esser.

Move the slider or tap the – and + buttons to adjust the following values.

- Threshold  
This sets the level that will cause the de-esser to start. The de-esser will reduce harsh high-frequency sounds, including sibilance, that exceed the threshold.

## 8 - Touchscreen Functions

- Frequency  
This sets the frequency that will be affected by the de-esser. Sounds higher than this frequency will be reduced.

### Noise suppressor settings (mic input)

The Noise Suppressor Setting Screen has two pages. (Tap the [>] button at the bottom of the Noise Suppressor Setting Screen to switch to the second page.) The first page of the Noise Suppressor Setting Screen is shown first.

- The following settings can be made on the first page of the Noise Suppressor Setting Screen.

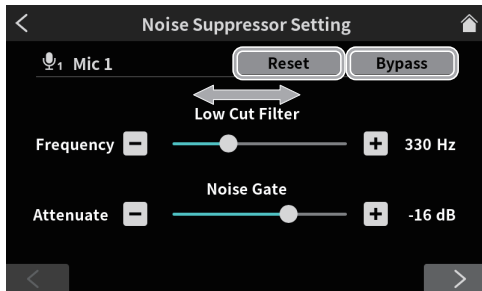

Noise Suppressor Setting Screen page 1

- Reset  
Tap this to restore changed settings to default values.
- Bypass  
Tap to bypass Noise Suppressor adjustments.

Move the slider or tap the – and + buttons to adjust the following values.

- Low Cut Filter Frequency  
Sounds lower than the set frequency will be cut.
- Noise Gate Attenuate  
This adjusts the amount of output volume attenuation. Sounds below the threshold level will be reduced to the level set here.
- The following settings can be made on the second page of the Noise Suppressor Setting Screen.

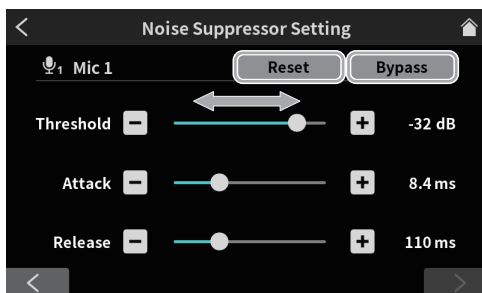

Noise Suppressor Setting Screen page 2

- Reset  
Tap this to restore changed settings to default values.
- Bypass  
Tap to bypass Noise Suppressor adjustments.

Move the slider or tap the – and + buttons to adjust the following values.

- Threshold  
This sets the level that will cause the noise suppressor to start. When the input sound goes below the threshold level, its volume will be restricted to the set Attenuate level.

- Attack  
This sets the time until the set Attenuate level is reached after the input volume goes below the threshold.
- Release  
This sets the amount of time until the attenuation stops and the sound returns to its normal level after the input sound goes above the threshold level.

### Ducking manual settings (mic input)

This opens the Ducking Manual Setting Screen.

#### NOTE

The ducking function can only be used with MIC INPUT 1. It is not available for MIC INPUT2–4.

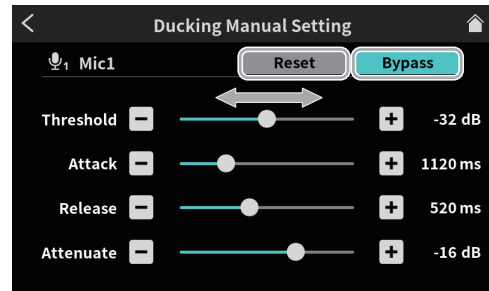

Ducking Manual Setting Screen

- Reset  
Tap this to restore changed settings to default values.
- Bypass  
Tap to bypass ducking adjustments.

Move the slider or tap the – and + buttons to adjust the following values.

- Threshold  
This sets the level that will cause ducking to start. When the input level of MIC INPUT 1 exceeds this level, the volume of all other inputs will be reduced.
- Attack  
This sets the time until the volume of other inputs is reduced to the level set by Attenuate after the MIC INPUT 1 volume exceeds the threshold level.
- Release  
This sets the amount of time until the attenuation of other inputs stops and their sounds return to normal levels after the MIC INPUT 1 volume goes below the threshold level.
- Attenuate  
This adjusts the amount that volume is reduced for inputs other than MIC INPUT 1. This sets the level to which the volume of other inputs is reduced after the MIC INPUT 1 sound exceeds the threshold level.

### 8-2-1-5. Effect Setting

Effect functions (reverb and voice changer) can be assigned to sound pads and used on mic inputs.

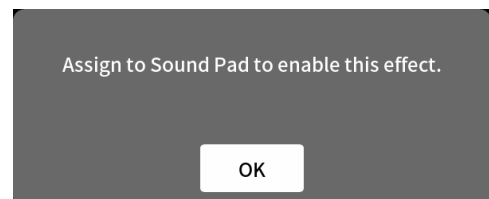

Check the message, and tap “OK” to open the first page of the Effect Setting Screen.

The Effect Setting Screen has two pages. (Tap the [>] button at the bottom of the Effect Setting Screen to switch to the second page.)

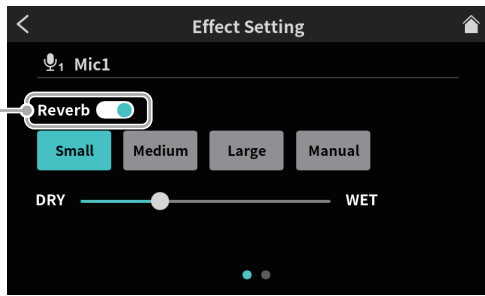

Effect Setting Screen page 1

## 1 Reverb switch (page 31)

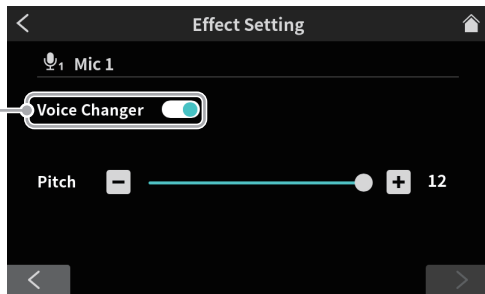

Effect Setting Screen page 2

## 2 Voice Changer switch (page 31)

### Reverb switch

Reverb can only be applied to one input channel. Reverb and voice changer effects cannot be used at the same time.

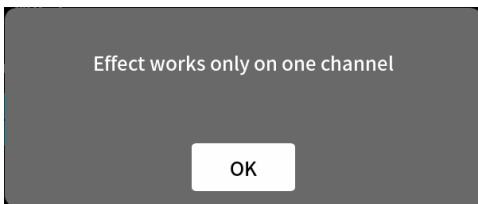

Confirm the message, and tap “OK” to turn the switch on and enable selecting from the following Reverb settings. Use the reverb to add reverberation to the sound, which is useful for various kinds of performance.

- Small** This has the smallest amounts of reflections and reverb sound.
- Medium (default)** This setting is between small and large.
- Large** This has the greatest amount of reflections and reverb sound.
- DRY/WET** Move the slider to adjust the amount of the reverb effect.
- Manual** This allows detailed reverb adjustments. Tap this to enable manual reverb settings and show the  setting icon. \*



- Tapping another icon will make the  settings icon disappear.

\*Tap the  settings icon to open the Reverb Manual Setting Screen (page 31).

### Voice Changer switch

Reverb can only be applied to one input channel. Reverb and voice changer effects cannot be used at the same time.

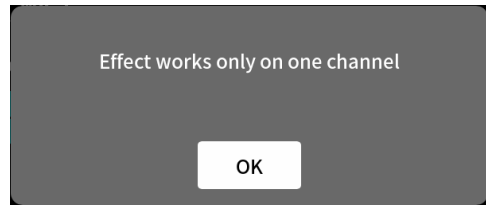

Confirm the message, and tap “OK” to turn the switch on and enable the Voice Changer settings.

The Voice Changer function can raise and lower the pitch of the input sound. The pitch can be raised or lowered by up to one octave.

Use the slider and the – and + buttons to adjust the Pitch.

### Reverb manual settings

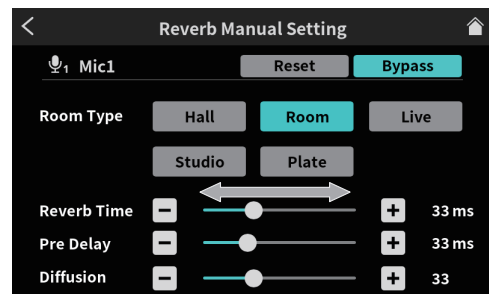

Reverb Manual Setting Screen

Tapping one of the Reverb Manual setting icons selects it, highlighting it and activating that setting.

- **Reverb Type selection**  
Depending on the reverb type, the density and level of the reverb sound changes.
  - Hall** Reverb sound like a concert hall
  - Room** Reverb sound like being in a room
  - Live** Reverb sound like being in a live performance venue
  - Studio** Reverb sound like being in a studio
  - Plate** Reverb like that made by a plate reverb
- **Reset**  
Tap this to restore changed settings to default values.
- **Bypass**  
Tap to bypass the reverb effect.

Move the slider or tap the – and + buttons to adjust the following values.

- **Reverb Time**  
This adjusts the amount of time that the reverberations continue. The larger the value, the longer they continue.
- **Pre Delay**  
This adjusts the delay time until the first reverberations. The larger the value, the larger the reverberations make the room sound.
- **Diffusion**  
This adjusts the width of the reverberations.

# 8 - Touchscreen Functions

## 8-2-2. USB settings

Tap the  icon to open the Level Screen.

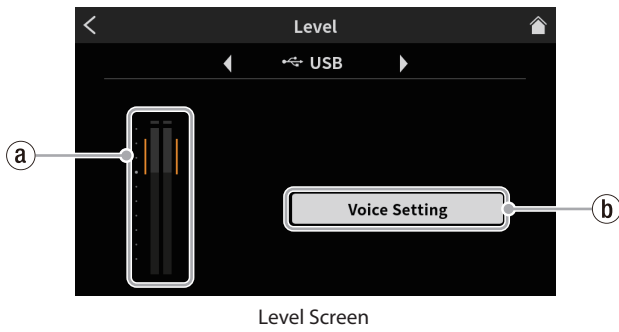

Level Screen

- ① USB input level (page 32)
- ② Voice settings (page 32)

### 8-2-2-1. USB input level

Adjust the device connected by USB so that the volume is not too high or low and the peak stays in the orange range on the level meter.

### 8-2-2-2. Voice settings

Tap to open the Voice Setting Screen.

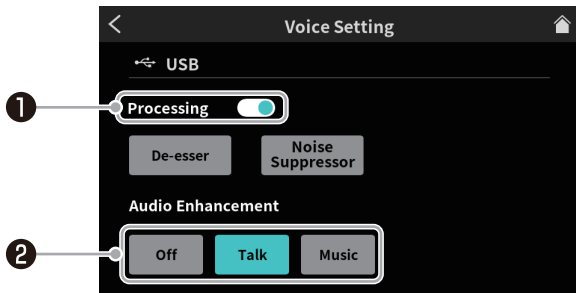

Voice Setting Screen

- ① Processing switch (page 32)
- ② Audio Enhancement (page 32)

#### Processing switch

Tap this to enable use of the following effects.

**De-esser** Reduce harsh high-frequency sibilant sounds.  
Tap this to enable the De-esser and show the  setting icon. \*



- Tapping the icon again will make the  setting icon disappear.

**Noise Suppressor** Reduce background noise.  
Tap this to enable the Noise Suppressor and show the  setting icon. \*



- Tapping the icon again will make the  setting icon disappear.

\*Tap the  settings icon to open the De-esser Manual Setting Screen or Noise Suppressor Setting Screen (page 32).

#### Audio Enhancement

Tap to enable selection of a scene that suits the input sound.

- Off** This disables the scene effect.
- Talk** This evens out the sound of voices to make speaking easier to hear.
- Music** This provides clear music playback.

## De-esser manual settings (USB)

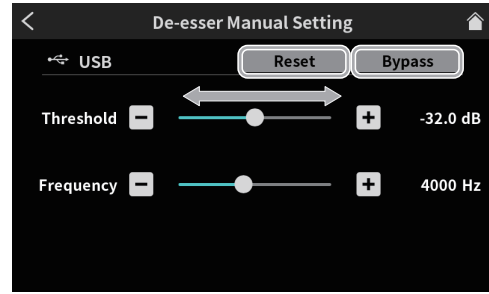

De-esser Manual Setting Screen

- **Reset**  
Tap this to restore changed settings to default values.
- **Bypass**  
Tap to bypass de-esser adjustments.

Move the slider or tap the – and + buttons to adjust the following values.

- **Threshold**  
This sets the level that will cause the de-esser to start. The de-esser will reduce harsh high-frequency sounds, including sibilance, that exceed the threshold.
- **Frequency**  
This sets the frequency that will be affected by the de-esser. Sounds higher than this frequency will be reduced.

#### Noise suppressor settings (USB)

The Noise Suppressor Setting Screen has two pages. (Tap the [ > ] button at the bottom of the Noise Suppressor Setting Screen to switch to the second page.)

The first page of the Noise Suppressor Setting Screen is shown first.

- The following settings can be made on the first page of the Noise Suppressor Setting Screen.

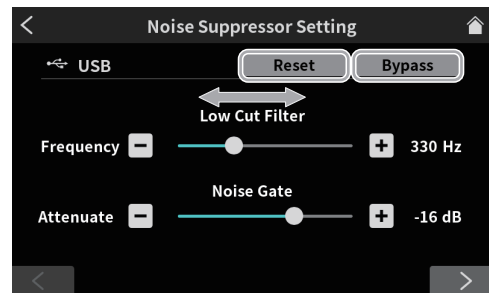

Noise Suppressor Setting Screen page 1

- **Reset**  
Tap this to restore changed settings to default values.
- **Bypass**  
Tap to bypass Noise Suppressor adjustments.

Move the slider or tap the – and + buttons to adjust the following values.

- **Low Cut Filter Frequency**  
Sounds lower than the set frequency will be cut.
- **Noise Gate Attenuate**  
This adjusts the amount of output volume attenuation. Sounds below the threshold level will be reduced to the level set here.
- The following settings can be made on the second page of the Noise Suppressor Setting Screen.



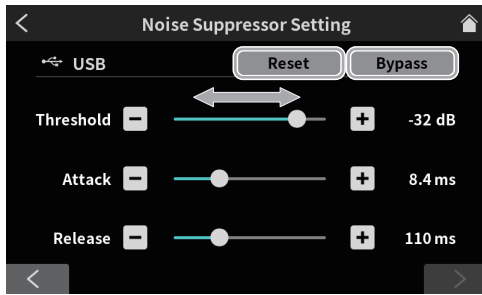

Noise Suppressor Setting Screen page 2

- **Reset**  
Tap this to restore changed settings to default values.
- **Bypass**  
Tap to bypass Noise Suppressor adjustments.

Move the slider or tap the – and + buttons to adjust the following values.

- **Threshold**  
This sets the level that will cause the noise suppressor to start. When the input sound goes below the threshold level, its volume will be restricted to the set Attenuate level.
- **Attack**  
This sets the time until the set Attenuate level is reached after the input volume goes below the threshold.
- **Release**  
This sets the amount of time until the attenuation stops and the sound returns to its normal level after the input sound goes above the threshold level.

### 8-2-3. Smartphone settings

Tap the smartphone icon to open the Level Screen.

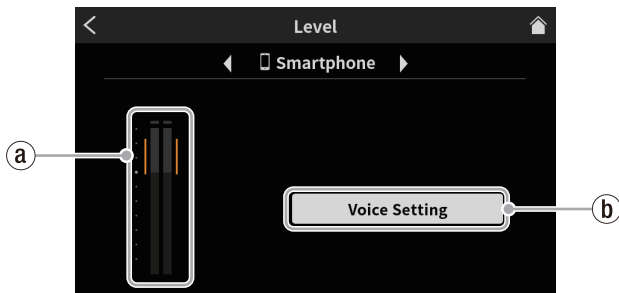

Level Screen

- ① **Smartphone input level (page 33)**
- ② **Voice settings (page 33)**

#### 8-2-3-1. Smartphone input level

Adjust the connected smartphone so that the volume is not too high or low and the peak stays in the orange range on the level meter.

#### 8-2-3-2. Voice settings

See "Voice settings" on page 32 for details about the Voice Setting Screen.

### 8-2-4. Bluetooth settings

Tap the icon to open the Level Screen.

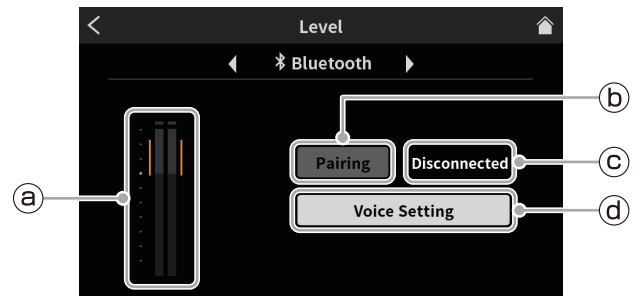

Level Screen

- ① **Bluetooth input level (page 33)**
- ② **Pairing (page 33)**
- ③ **Connection status (page 33)**
- ④ **Voice Setting (page 33)**

#### 8-2-4-1. Bluetooth input level

Adjust the connected Bluetooth device so that the volume is not too high or low and the peak stays in the orange range on the level meter.

#### 8-2-4-2. Pairing

Tap to start pairing. Make pairing settings on the other Bluetooth device. (See "Connecting with Bluetooth devices" on page 11.)

- Device name of this unit: TASCAM Mixcast

#### 8-2-4-3. Connection status

- Not connected with a Bluetooth device: "Not connected"
- Connecting with a Bluetooth device: "Connecting..."
- Connected with a Bluetooth device: "Connected"

#### 8-2-4-4. Voice Setting

See "Voice settings" on page 32 for details about the Voice Setting Screen.

## 8-3. Playback settings

Tap the play icon to open the podcast PLAY Screen.



PLAY Screen

- ① **Podcast list**  
This shows the names of podcasts that have been recorded. Tap to select the desired podcast.
- ② **Play icon**  
Tap this to play the selected podcast.  
During playback, the play icon will change to the pause icon.  
Tap the pause icon during playback to pause playback.

## 8 - Touchscreen Functions

### ③ Advanced button

This allows overwrite recording of the selected podcast from the desired position.

Tap it to open the following Advanced Screen.

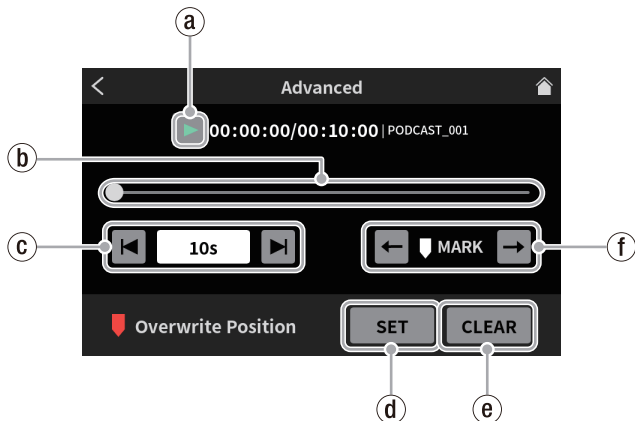

Advanced Screen

### ④ Play icon

Tap this to play the selected podcast. During playback, the ► play icon will change to the || pause icon.

### ⑤ Timeline and cursor

The playback position can be changed as desired by moving the slider on the timeline.

### ⑥ Time jumping controls

Tap the time display field to show and select from the following forward/backward jump times.

- 1s, 5s, 10s (default), 30s

After selecting the jump time, tap the ◀ and ▶ icons to find the position where overwriting should start.

### ⑦ SET button

Press the SET button to open a confirmation message. Tap "OK" to show a mark at the set overwrite starting position.

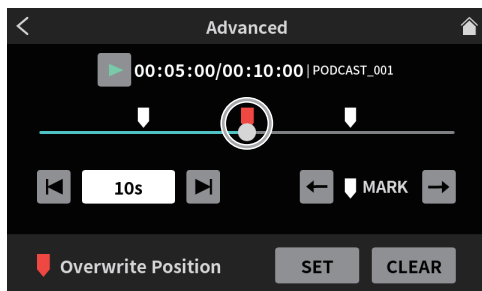

Advanced Screen

### ⑧ CLEAR button

This clears the mark (overwrite starting position) shown by the SET button.

### ⑨ Mark jump controls

When playing a podcast that already has marks\* added to it, tap the ◀ and ▶ icons to move the slider directly to them on the timeline.

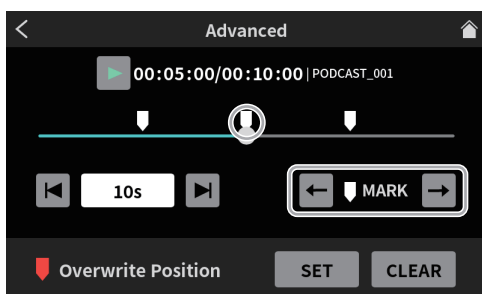

Advanced Screen

about marks.

### ④ Rename icon

Tap to open the following screen keyboard.

Use the screen keyboard to change the podcast name.



RENAME Screen

- Tap "Aa" on the keyboard to switch between uppercase letters, lowercase letters, and numbers and symbols.
- When input is complete, tap "OK" on the screen keyboard to confirm.
- If wrong characters are input, tap "Del" to delete one character at a time.

### ⑤ Trash icon

Tap the 🗑️ trash icon to delete the selected podcast.

## 8-4. Sound pad settings

Tap the 🎛️ Sound Pad icon to open the settings for Sound Pads assigned in the dedicated software.

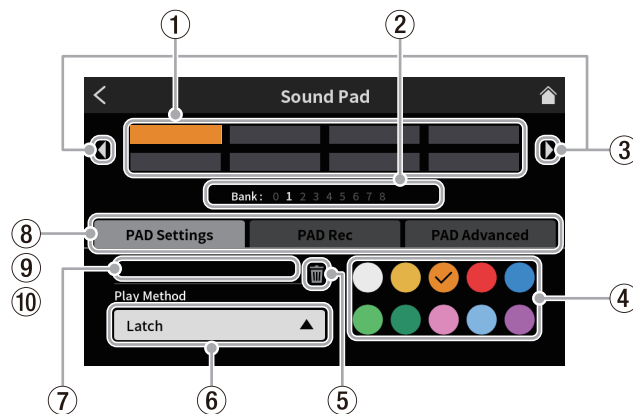

Sound Pad Screen

### ① Pads

Tap a pad to check or change the function assigned to it. These are linked to the Sound Pad buttons on the unit (12).

### ② Sound Pad Bank indicators

The number of the currently selected bank is highlighted.

### ③ Sound Pad Bank switch icons

Tap the ◀ icon to switch to the lower-numbered bank.  
Tap the ▶ icon to switch to the higher-numbered bank.

### ④ Pad color setting

The color of the selected pad can be changed.

### ⑤ Trash icon

Tap this icon to clear the settings and functions assigned to the selected pad.

### ⑥ Play Method

This shows how the effect sound or BGM of the selected pad will be output.

The output mode can also be selected and changed.

Tap the button and select one of the following play methods.

\*See "Adding marks during playback" on page 19 for information

- Latch** Press once to start playback, and once again to stop it. Press again to play from the beginning. If nothing is done, the file will play to its end before stopping.
- Pause** Press once to start playback, and once again to pause. Press again to resume playback. If nothing is done, the file will play to its end before stopping.
- RePlay** Press once to start playback. Press again to restart playback from the beginning. If nothing is done, the file will play to its end before stopping.
- One Shot** Press once to start playback. The file will play to its end. To stop during playback, press and hold the pad button.
- Repeat** Press once to start playback, and once again to stop it. Press again to play from the beginning. If nothing is done, the file will play repeatedly.
- Touch** The sound will play only while the pad is being pressed.

### ⑦ Sound source file name

This shows the name of the sound source file shown on the pad.

### ⑧ PAD Settings

- The desired color can be selected and set with the pad color setting (④). These colors are also applied to the Sound Pad buttons on the unit (⑫).
- How effects and BGM are output can be set with the Play Method button (⑥).

### ⑨ PAD Rec

Effect sounds and BGM can be captured from each input signal. Operate the channel faders of the input signals you want to record (⑬), and tap the "● Rec Start" button to start recording.

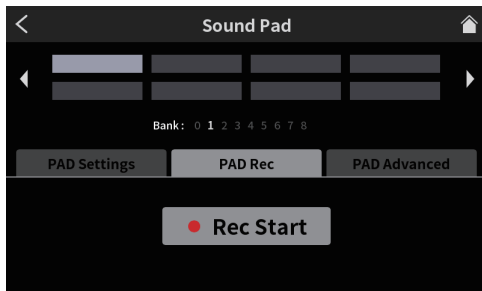

Sound Pad Screen ready to record

- While recording, the "■ Rec Stop" button is shown. Tap this to stop recording.

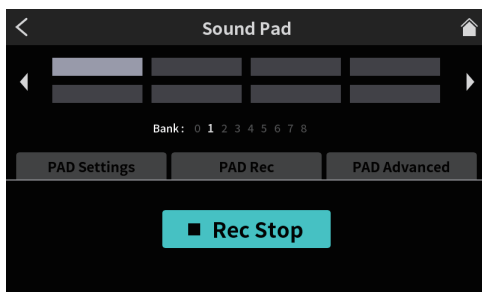

Sound Pad Screen ready to stop recording

### ⑩ PAD Advanced

Apply mic setting effect settings. (See "Assigning effects to Sound Pads" on page 24.)

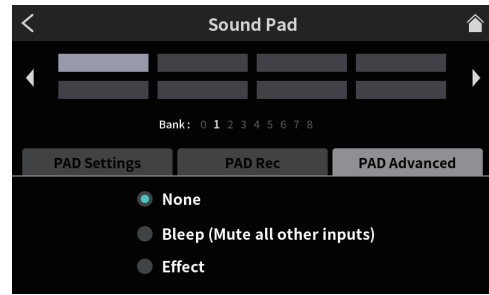

Pad Screen showing advanced options

- None  
No advanced option set.
- Bleep (Mute all other inputs)  
This sets a bleep sound.  
For example, when the bleep sound is assigned to a pad, sound that you do not want to record can be overwritten for as long as the pad is pressed.

### NOTE

The bleep sound is output at a fixed volume. (It is not affected by the pad channel fader.)

- Effect  
Settings made on the Effect Setting screen, as explained in See "Mic settings" on page 27, can be assigned to pads. For example, a sound adjusted with the Voice Changer function on the Effect Setting Screen for Mic Input 1 can be assigned to a pad, and that sound can be played for as long as the pad is pressed during recording.

## 8-5. Hardware Settings

Tap the  hardware settings icon to access the following settings.

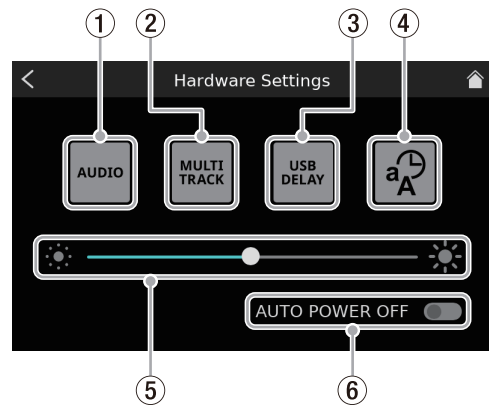

Hardware Settings Screen

- ① AUDIO (page 36)
- ② MULTI TRACK (page 36)
- ③ USB DELAY (page 36)
- ④ Other settings (page 36)
- ⑤ Brightness adjustment (page 37)
- ⑥ AUTO POWER OFF (page 37)

## 8 - Touchscreen Functions

### 8-5-1. AUDIO

Tap the  AUDIO icon to open the Audio Settings Screen.

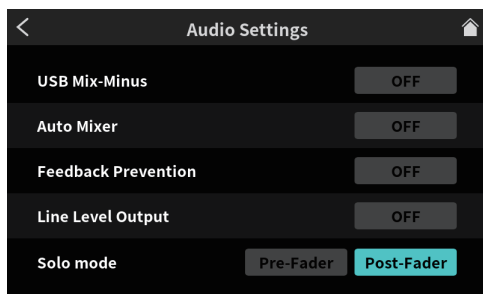

Audio Settings Screen

#### 8-5-1-1. USB Mix-Minus

Options: ON, OFF (default)

By turning this function on when conducting a telephone interview or remote recording using a smartphone or computer, the return of sound being recorded and the generation of echo at the other end can be prevented.

#### 8-5-1-2. Auto Mixer

Options: ON (default), OFF

By turning this function on, adjustments will be made automatically to keep the output sound at a fixed level while maintaining the balance of the inputs.

#### 8-5-1-3. Feedback Prevention

Options: ON, OFF (default)

By turning this function on, MUTE switches are automatically activated on channels when their inputs become saturated, suppressing feedback caused when sound from speakers is returned to mics.

#### 8-5-1-4. Line Level Output

Options: ON, OFF (default)

Turning this function on keeps the output level of the MONITOR OUT and LINE OUT jacks at a standard level and disables the MONITOR OUT knob (5) on the top of the unit. This setting is turned off when the unit is turned off.

#### 8-5-1-5. Solo Mode

Options: Pre-Fader, Post-Fader (default)

When Pre-Fader is selected, input sounds can be heard before they are affected by fader and muting settings.

### 8-5-2. MULTI TRACK

Tap the  MULTI TRACK icon to open the Multi Track Screen.

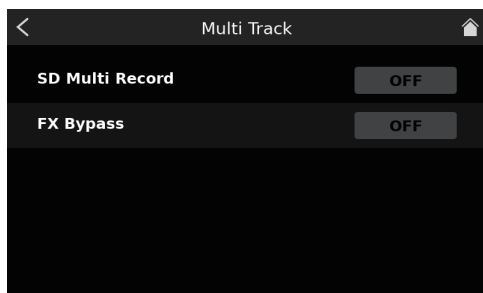

Multi Track Screen

#### 8-5-2-1. SD Multi Record

Options: ON (default), OFF

When on, 14 channels, including all inputs and the stereo mix, will be recorded. When off, only the stereo mix will be recorded.

#### 8-5-2-2. FX Bypass

Options: ON, OFF (default)

When this function is on, the pre-fader audio will be multitrack recorded. The stereo mix, however, will record the post-fader audio, including effects.

### NOTE

These settings are also applied to sound output by USB.

### 8-5-3. USB DELAY

Tap the  USB DELAY icon to open the USB Delay Screen.

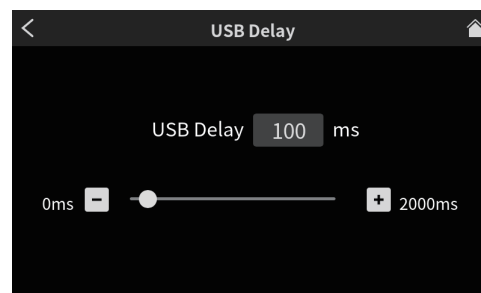

USB Delay Screen

- Use the slider and the [-] and [+] buttons to adjust the USB Delay time. (The default value is "0".)
- The stereo mix signal is delayed by the set time.

#### 8-5-3-1. USB delay function explanation

During live Internet streaming, lags sometimes occur between streamed video and audio when camera video and audio are captured by different devices.

If the video is behind the audio, an offset delay can be added intentionally to the audio from the USB output to correct the lag between the video and audio.

### 8-5-4. Other settings

Tap the  other settings icon to open the Others Screen.

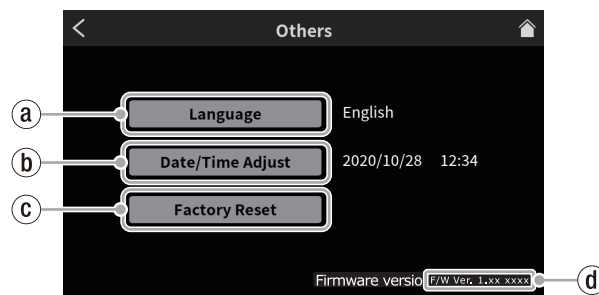

Others Screen

- (a) Language (page 36)
- (b) Date/ Time Adjust (page 37)
- (c) Factory Reset (page 37)
- (d) Firmware version (page 37)

#### 8-5-4-1. Language

Select the language used for menus and messages.

Options

- English: Use English (default setting)
- 日本語: Use Japanese
- Français: Use French
- Español: Use Spanish
- Deutsch: Use German
- Italiano: Use Italian
- Русский язык: Use Russian
- 中文: Use Chinese
- 한글: Use Korean

## 8-5-4-2. Date/Time Adjust

Tap this to open the Date/Time Adjust Screen shown below.

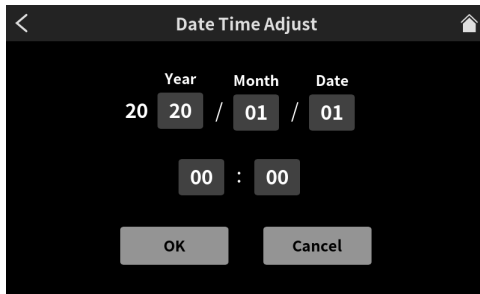

Date/Time Adjust Screen

Swipe the year (last two digits of Western calendar), month, date and time up and down to set them.

After checking the input values, tap the "OK" button to confirm.

## 8-5-4-3. Factory Reset

Tap this to restore the various settings stored in the memory of the unit to their factory default values.

Tap this button to open a confirmation message. Tap "OK" to start initializing.

## 8-5-4-4. Firmware version

This shows the current firmware version.

## 8-5-5. Brightness adjustment

Move the slider left and right to change the brightness of the touchscreen and the unit LEDs.

- Move the slider left (toward ☹️) to make them dimmer or right (toward 😊) to make them brighter

## 8-5-6. AUTO POWER OFF

When the AUTO POWER OFF switch is on, the unit will turn itself off automatically if no input signal\* (above -60 dBFS) has been detected and no operation has been conducted for 30 minutes.

- We recommend leaving the AUTO POWER OFF switch off normally during use.

\*Even when connected by Bluetooth or USB, the unit will turn off automatically after the above time if no audio is input.

## 8-6. SD Settings

Tap the SD settings icon to access the following settings.

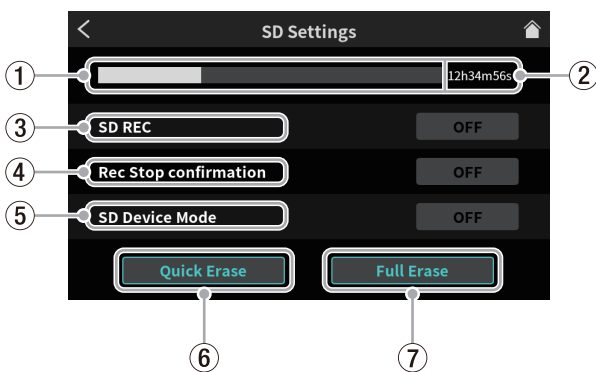

SD Settings Screen

- ① SD card space used (page 37)
- ② SD card available recording time (page 37)
- ③ SD REC (page 37)
- ④ Rec Stop confirmation (page 37)
- ⑤ SD Device Mode (page 37)

- ⑥ Quick Erase (page 38)

- ⑦ Full Erase (page 38)

## 8-6-1. SD card space used

This bar graph shows the amount of space used on the SD card.

## 8-6-2. SD card available recording time

This shows the remaining time available for recording on the SD card.

## 8-6-3. SD REC

Options: ON (default), OFF

- When this function is on, podcasts will be recorded to the SD card. When this is off, podcasts will not be recorded to the SD card.
- Turn this function off to record only to the dedicated software connected to this unit.

## 8-6-4. Rec Stop confirmation

Options: ON (default), OFF

If this function is on, a confirmation pop-up message will appear when stopping podcast recording.

## 8-6-5. SD Device Mode

Options: ON, OFF (default)

If this function is on, the SD card in this unit can be used as USB mass storage with another device connected by USB.

Tapping this button will open the following message.

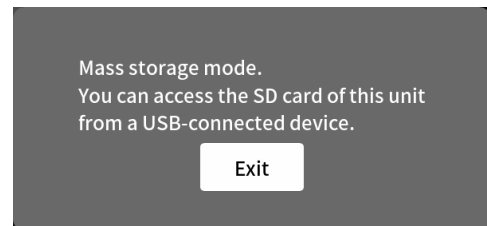

### ATTENTION

To avoid data loss, follow the procedures for removing media on the computer before removing an SD card from the unit or tapping the Exit button.

- Tap "Exit" to end SD Device Mode.

### NOTE

- If use as USB mass storage does not work properly with an Android device, turn on SD Device Mode on this unit before connecting with the Android device. Furthermore, an issue exists with some Android devices that will not recognize this unit as USB mass storage. For details, see the TEAC Global Site (<http://teac-global.com/>).
- When connection is made, this unit will appear as the "Mixcast4" drive on the device connected by USB.
  - It will appear in Explorer on Windows OS and on the desktop in Mac OS.
  - It will appear inside the File app on iOS devices.
- This unit's recording and playback functions cannot be used when it is in SD Device Mode.

## 8 - Touchscreen Functions

### 8-6-6. Quick Erase

This formats the SD card quickly.

Tapping this button will open the following message.

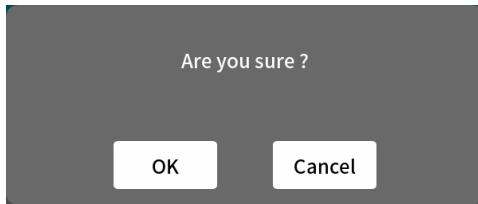

Tap "OK" to begin quick formatting.

### 8-6-7. Full Erase

This formats the SD card completely.

Tapping this button will open the following message.

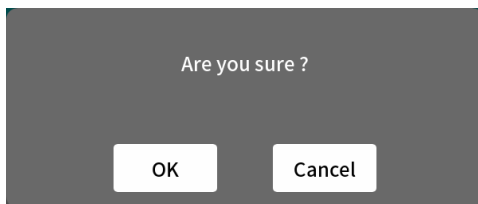

Tap "OK" to begin full formatting.

#### **NOTE**

- Both Quick Erase and Full Erase delete all data on the SD card.
- The writing speeds to SD cards and other storage media that use flash memory tend to decrease after writing occurs repeatedly. If the writing speed decreases, this could have a negative impact on recording.

Using the Full Erase function of this unit should restore the writing speed of the SD card. \*

For this reason, we recommend using the Full Erase function at the following times.

- Whenever the card has been written to until it became completely full
- On a regular schedule (about once per month)
- Before starting important recordings

\*Writing speed might not be restored depending on the SD card condition (including malfunction and age).

## 9 - Error messages

The following is a list of pop-up messages that are shown when errors occur.

Refer to this list if one of these pop-up messages appears on the this unit and you want to check the meaning or determine a proper response.

Message	Meaning and response
Invalid Card Change Card	Something might be wrong with the card. Change the card.
Protected Card Change Card	The SD card is write-protected. Disable SD card write-protection.
Protected Card	
MBR ERROR Init CARD Are you sure?	The SD card is not formatted properly or the card is broken. Change the SD card, or press the OK button while this message is being shown to format the card. Formatting will erase all the data on the SD card.
Format Error Format Card Are you sure?	
No Card	No SD card is loaded. Insert a recordable SD card.
Music Not Found Are you sure?	The file cannot be found or the file may be damaged. Check the relevant file.
File Not Found	
File Not Found Make Sys File Are you sure?	A system file required to use this unit is missing. A necessary system file might also be invalid.
Invalid SysFile Make Sys File Are you sure?	If this message appears, press the OK button to create a system file.
Write Timeout	Writing to the SD card timed out and recording stopped. SD card writing performance has become worse. Execute the erase format function or change the SD card.
Write error REC continue	Writing to the SD card timed out. This has caused audio to be interrupted and noise to occur.
File Number Full	The total number of folders and files exceeds the limit of 5000. Delete unnecessary folders and files or move them to a computer.
Card Full	The SD card has no remaining capacity.
Max File Size	Recording stopped because the recording time reached 24 hours.
File Name Error	The file name is either invalid or too long. Change the file name.
Duplicate File Name	A file with the same name already exists. Change the file name.
Card Error FATAL	The SD card cannot be recognized properly. Replace the SD card.
MARK FULL	The number of marks has reached the limit of 99.
Set SD REC to ON.	Set SD REC to ON to enable overwrite recording.
No USB Connection	The recording button was pressed when there was no USB connection and SD REC was set to off.
System Rom Error	If any of these errors occurs, turn the unit off and restart it. If these error messages continue to appear frequently, please contact the store where you purchased this unit or TASCAM customer support service.
Initialize error Are you sure?	
Not Continued	
File Error	
Writing Failed	
Player Error	
System Error XX FATAL (XX is a number.)	
Can't Enter	

# 10 - Troubleshooting

If you are having trouble with the operation of this unit, please try the following before seeking repair.

If these measures do not solve the problem, please contact the store where you bought the unit or TASCAM customer support service.

## Power will not turn on

- Confirm that the power plug and other connectors are inserted completely.

## The SD card is not recognized

- Confirm that the SD card is inserted completely.
- Is an SD card supported by the unit loaded?  
Confirm that SD cards are supported before using them.
- Confirm that the SD card being used is properly formatted.  
Back up necessary data to a computer or other device and format the SD card again.
- If the unit stops responding to operations after loading an SD card, a problem is occurring with the SD card connection. Remove and re-insert the SD card.

## No sound is output

- Confirm that the MONITOR OUT and/or PHONES **1** - **4** knobs as well as the faders are raised to suitable levels.
- Are any of the channel SOLO or MUTE buttons on?
- Confirm that mics and other audio sources are connected correctly to the input jacks.
- Confirm the input level settings and audio source settings are correct.  
Check the settings of the inputs and the connected equipment again.
- Is a monitoring system correctly connected to the MONITOR OUT or LINE OUT jacks?  
Is the monitoring system set up correctly?  
(See "Connecting recording devices and monitor speakers" on page 11.)

## The sound I want to record is distorted

- Confirm that the input levels of the channels are suitable.  
Confirm that the input source levels are not too high.
- Confirm that the Voice Setting of each input is suitable.
- Confirm that the channel faders and the MONITOR OUT knob are not raised too high.
- Is the monitoring level too high, causing the monitoring system to distort?

## Recording is not possible

- Confirm that the SD card has enough open space.
- Recording becomes impossible when the podcast name reaches "PODCAST\_999".

## Playback is not possible

- Confirm that the file uses the sampling frequency (48 kHz) and bit depth (24-bit) supported by this unit.

## There is noise

- Confirm that the connection cables do not have contact issues.
- If this unit is near a TV, radio, power amplifier or other device with a large transformer, noise could occur with this unit or other devices nearby. (See "Precautions for placement and use" in the Owner's Manual.)

## Sound via Bluetooth breaks up or is noisy

- Are there any wireless LAN devices, other Bluetooth devices, microwave ovens or similar equipment nearby?  
Keep such devices as far away as possible during use.
- Try reducing the distance between this unit and the other Bluetooth device. Try changing the positions of this unit and the other Bluetooth device.
- Depending on the settings of the device connected by smartphone, the operation of apps other than for music playback could cause the sound to break up. In this case, stop operation of apps other than the one used for music playback.

## Cannot connect or communication is interrupted when using Bluetooth

- Confirm that the other Bluetooth device power is on and that its Bluetooth function is on.
- Confirm that the other Bluetooth device is not too far away.  
Are there walls or other obstacles, for example, between this unit and the other Bluetooth device?
- Try changing the positions of this unit and the other Bluetooth device.
- Turn the unit off once and restart it.
- Remove the "TASCAM Mixcast" pairing record from the other Bluetooth device, and try pairing the unit with it again. (See "Connecting with Bluetooth devices" on page 11.)

## Cannot pair with another Bluetooth device

- Confirm that the other Bluetooth device supports A2DP.
- Confirm that the other Bluetooth device is in a state that allows transmission. For details, check the operation manual of that Bluetooth device.
- Turn the power off for both this unit and the other Bluetooth device once. Then, turn them both on and try pairing them again.
- Turn off Bluetooth devices other than the one that you are trying to pair with.
- Remove the "TASCAM Mixcast" pairing record from the other Bluetooth device, and try pairing the unit with it again. (See "Connecting with Bluetooth devices" on page 11.)

## A computer does not recognize the unit when connected by USB

- This unit cannot be used with USB 1.1. Use a USB 2.0 or USB 3.0 port.
- Do not use a USB hub with this unit. Always connect the unit directly to a USB port on the computer.
- If the above methods do not resolve the problem, connect the unit to a different USB port on the computer.

## Feedback occurs when connected by USB

- Feedback could occur depending on the settings. Mixing the sound input into the unit with sound from the computer and sending it back to the computer and then to the unit again will cause the sound to be repeated and amplified.  
When using a DAW or other recording software, turn input monitoring off for all channels.



### Noise occurs or sound drops out when connected by USB

When noise and dropouts occur while using this product, the cause is often excessive CPU load on the connected computer. In particular, wireless LAN or antivirus software, for example, running in the background can noticeably cause noise and sound drop outs.

Please try the following basic countermeasures.

#### NOTE

Depending on the system, compatibility issues with the computer might prevent proper operation.

Please understand beforehand that there are no perfect solutions to ensure problem-free use with every computer.

#### ● Checklist when noise occurs or sound drops out

Connect this unit by USB directly to the computer.\* Do not use a USB hub.

Restart the computer before beginning.

\*When using a desktop computer, disconnect all USB devices other than this unit, a keyboard and a mouse. When using a laptop computer, disconnect all USB devices other than this unit.

1. Confirm that the operating system is compatible with this product.  
Always complete all operating system updates and use the latest version.
2. Confirm that the product firmware is the latest version.
3. When using software that uses the ASIO driver on Windows, confirm that the driver is the latest version.
4. When using Windows, disable all devices other than this one for "Recording" and "Playback" in the Windows Sound settings (Sound Control Panel).
5. When using Windows, check the power settings.
  - In the "USB settings", set the "USB selective suspend setting" to "Disabled".
  - Set "Processor power management" "Minimum processor state" to "100%".
6. Adjust the buffer size.  
Raise or lower the default setting value of 256 one step at a time, With software that uses the ASIO driver, open the Settings Panel from the software.
7. Change the USB port and USB cable.  
Try connecting to a USB 2.0 port on the computer if it has one.
8. When using macOS, try resetting the NVRAM (or PRAM) and the SMC.
  - <https://support.apple.com/ja-jp/HT204063>
  - <https://support.apple.com/ja-jp/HT201295>
9. Stop antivirus software and other software running in the background, and disable wireless LAN. Then, check whether the problem continues to occur.

# 11 - Specifications and Ratings

## Recorder specifications

### Recording media

SD cards	(64 MB–2 GB)
SDHC cards	(4 GB–32 GB)
SDXC cards	(48 GB–512 GB)

### Recording/playback formats

WAV 48 kHz, 24-bit, 2-channel stereo/14-channel poly (BWF format)

### Recordable Channel

14 channels maximum (12 channels + stereo mix)

## Analog audio input ratings

### MIC INPUT jacks (1-4)

Connectors	XLR/TRS combo jacks
XLR	XLR-3-31 (1: GND, 2: HOT, 3: COLD)
TRS	6.3mm (1/4") standard TRS jacks (Tip: HOT, Ring: COLD, Sleeve: GND)
Maximum input level	+10dBu(when LEVEL at min.)
Nominal input level	–10 dBu (when LEVEL at min.)
Minimum input level	–76.5 dBu (when LEVEL at max.)
Gain range	66.5 dB
Input impedance	2.1 k $\Omega$

### PHONES (TRRS) jack (CTIA standard)

Connector	3.5 mm (1/8") 4-pole mini jack
Maximum input level	+4 dBV(when LEVEL at min.)
Nominal input level	–16 dBV (when LEVEL at min.)
Minimum input level	–82.5 dBV (when LEVEL at max.)
Gain range	66.5 dB
Input impedance	2 k $\Omega$

### LINE IN (TRRS) jack (CTIA standard)

Connector	3.5 mm (1/8") 4-pole mini jack
Maximum input level	+8 dBV
Nominal input level	–12 dBV
Input impedance	12 k $\Omega$

### LINE IN L/R (balanced) jacks



Connectors	6.3mm (1/4") standard TRS jacks (Tip: HOT, Ring: COLD, Sleeve: GND)
Maximum input level	+24 dBu
Nominal input level	+4 dBu
Input impedance	11 k $\Omega$

## Analog audio output ratings

### PHONES jacks –

Connectors	6.3mm (1/4") standard stereo jacks
Maximum output	45 mW + 45 mW (0.1% THD+N or less, into 32 $\Omega$ load)

### PHONES (TRRS) jack (CTIA standard)

Connector	3.5 mm (1/8") 4-pole mini jack
	● PHONES (TRRS)  output splits from PHONES  output.

### LINE OUT (TRRS) jack (CTIA standard)

Connector	3.5 mm (1/8") 4-pole mini jack
Maximum output level	–25 dBu
Nominal output level	–45 dBu
Output impedance	100 $\Omega$

### MONITOR OUT L/R (balanced) jacks

Connectors	6.3mm (1/4") standard TRS jacks (Tip: HOT, Ring: COLD, Sleeve: GND)
Maximum output level	+20 dBu
Nominal output level	+0 dBu
Output impedance	200 $\Omega$

### LINE OUT jack

Connectors	3.5mm (1/8") stereo mini jacks
Maximum output level	+6 dBV
Nominal output level	–14 dBV
Output impedance	200 $\Omega$

## Audio performance

### Mic amp EIN (equivalent input noise)

–125 dBu or less (150 $\Omega$  termination, LEVEL at max.)

### Frequency response

Mic input jacks (1-4)  
20 Hz – 20 kHz +0.3 dB/–0.3 dB (JEITA)

### S/N ratio

101 dB  
(Mic input jacks (1-4), channel faders at 0, 20kHz SPCL LPF +A-Weight)

### Distortion

0.003%  
(Mic input jacks (1-4), 1kHz sine wave, channel faders at 0, 20kHz SPCL LPF)

### Crosstalk

- 95 dB or more
- 0dBu=0.775Vrms
  - 0dBV=1Vrms

## Recording times (in hours: minutes)

Recording format	SIZE		
	4 GB	8 GB	
24-bit/48kHz WAV	14 ch.	0:35	1:10
	2 ch.	4:07	8:15

- The recording times shown above are not continuous recording times. They are total recordable times for SD/SDHC/SDXC cards.

---

## USB specification

---

Connector	USB Type-C
Formats	USB2.0 High-Speed, Mass-storage class/USB Audio Class 2.0 (USB class-compliant)

---

## USB Audio

---

Sampling Rate	48 kHz
Bit Depth	24 bit
Number of inputs	14 channels (Output from this unit)
Number of outputs	2 channels (Input to this unit)

---

## Bluetooth

---

Output class: 2 (about 10m\* unobstructed transmission distance)

Supported profile: A2DP

Supported A2DP codecs: SBC, AAC

Supported A2DP content protection: SCMS-T

\*The transmission distance is an estimate. The transmission distance may vary depending on the surrounding environment and radio wave conditions.

---

## Computer system requirements

---

Check the TEAC Global Site (<https://teac-global.com/>) for the latest information about supported operating systems.

Operation with each OS was confirmed with standard system setups that met the following conditions.

Operation is not guaranteed, however, with all systems that meet the following conditions.

---

### Windows

#### Supported operating systems

Windows 10 64-bit

#### Computer hardware requirements

Windows computer with a USB 2.0 (or higher)

Note: Operation is not guaranteed using the TASCAM driver with ARM64 CPUs.

---

### Mac

#### Supported operating systems

macOS Big Sur (11)

macOS Catalina (10.15)

#### Computer hardware requirements

Mac with a USB 2.0 (or higher)

---

### iOS/iPadOS devices

iOS 14 / iPadOS 14

iOS 13 / iPadOS 13

---

### Android devices

Android 11

Android 10

\*Compatibility has been confirmed, but this does not guarantee operation with all devices.

---

## Other

---

### Power

Dedicated AC adapter (PS-P1220E NUT), DC12V

### Power consumption

12.5 W (maximum)

### Weight

2.55 kg

### Operating temperature range

0–40°C

### Dimensions

374.8 × 56.5 × 263.6 mm

(width × height × depth, excluding protrusions)

374.8 × 71.2 × 266.7 mm

(width × height × depth, including protrusions)

# 11 - Specifications and Ratings

## Dimensional drawings

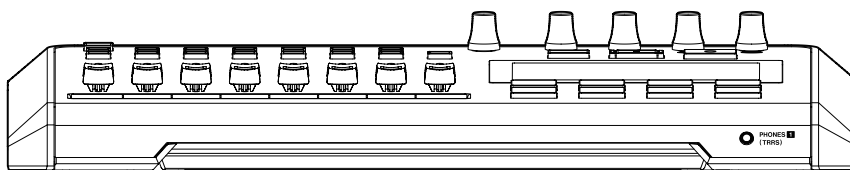
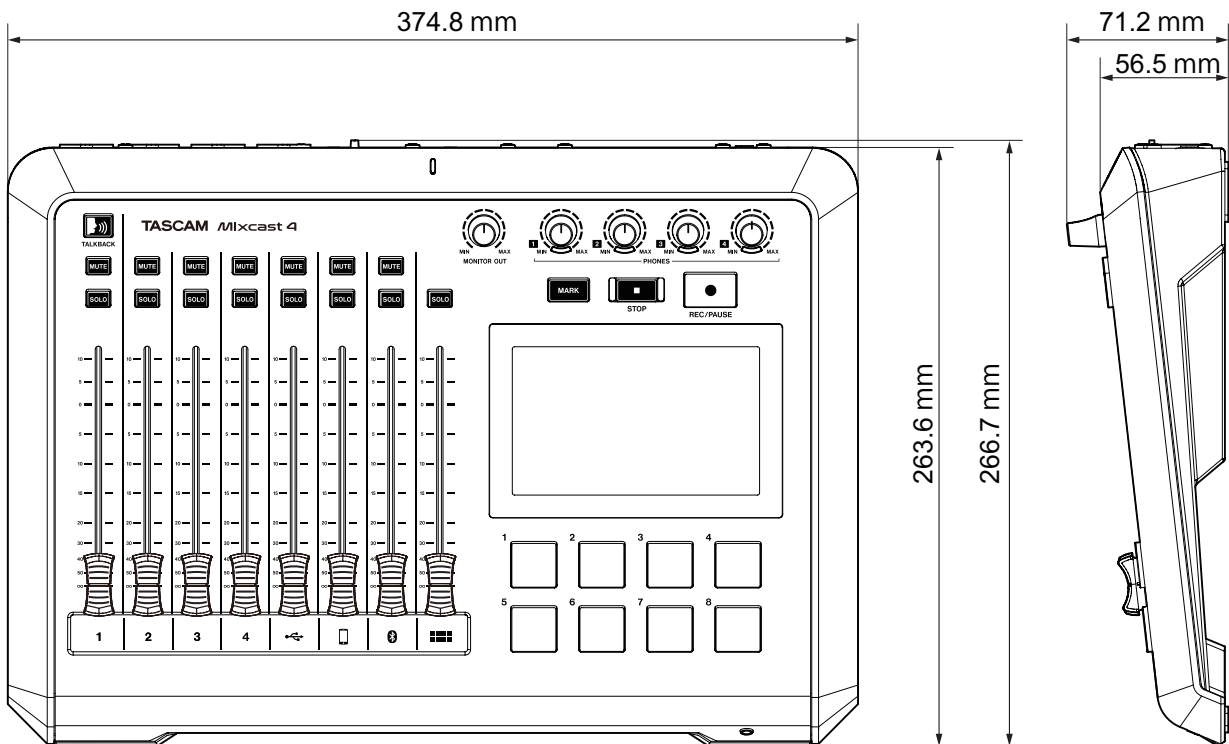
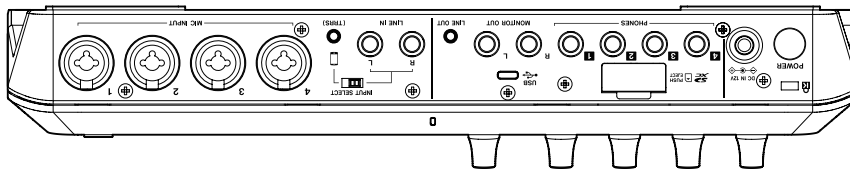

Block diagram

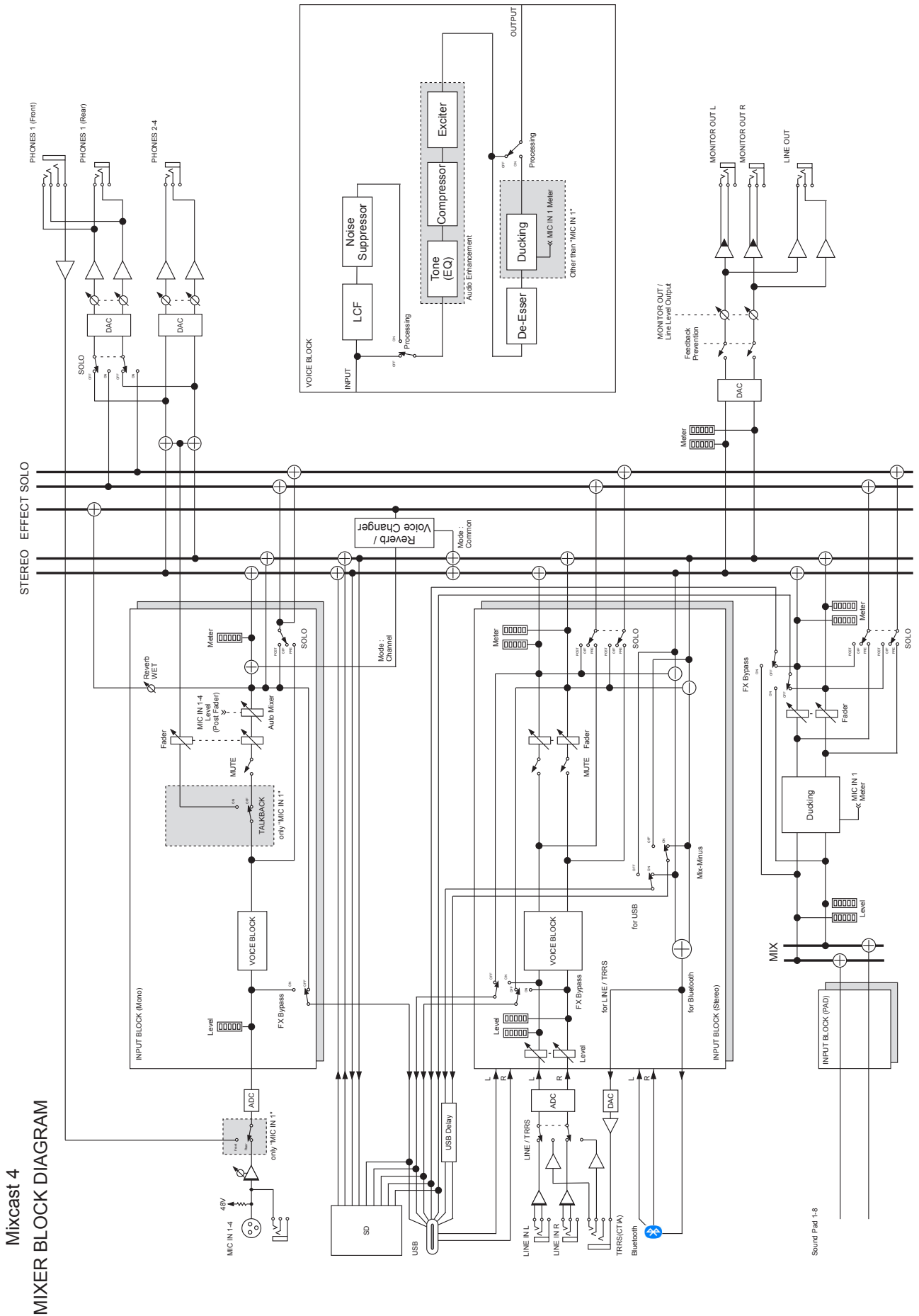

Mixcast 4  
MIXER BLOCK DIAGRAM

Sound Pad 1-8

## Level diagram

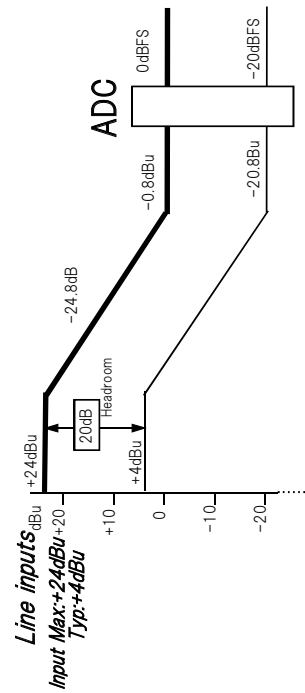
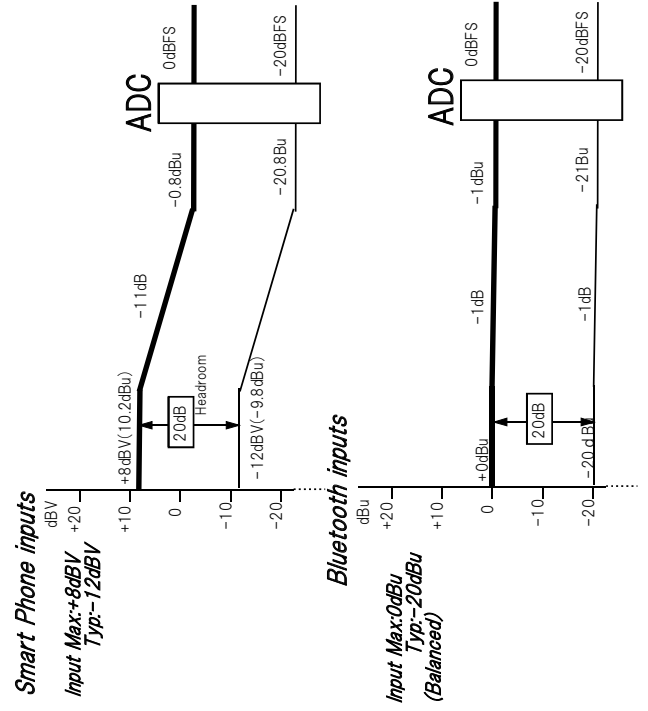
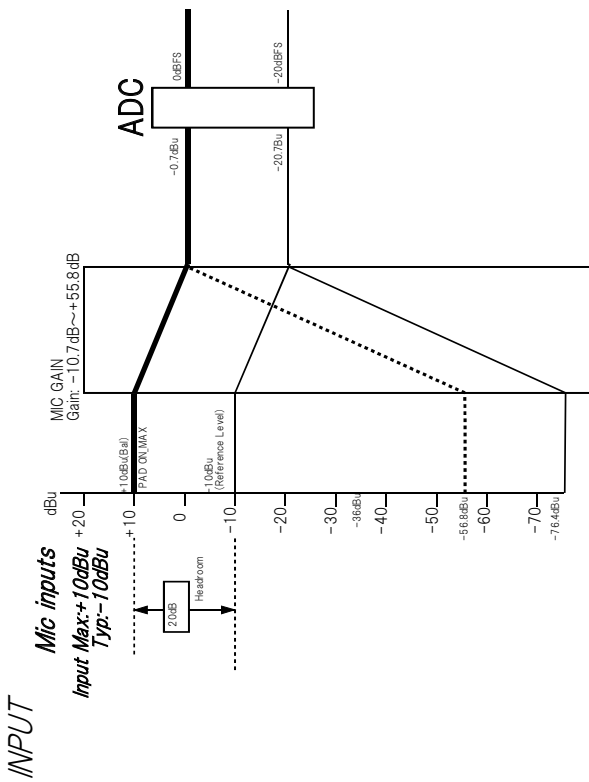
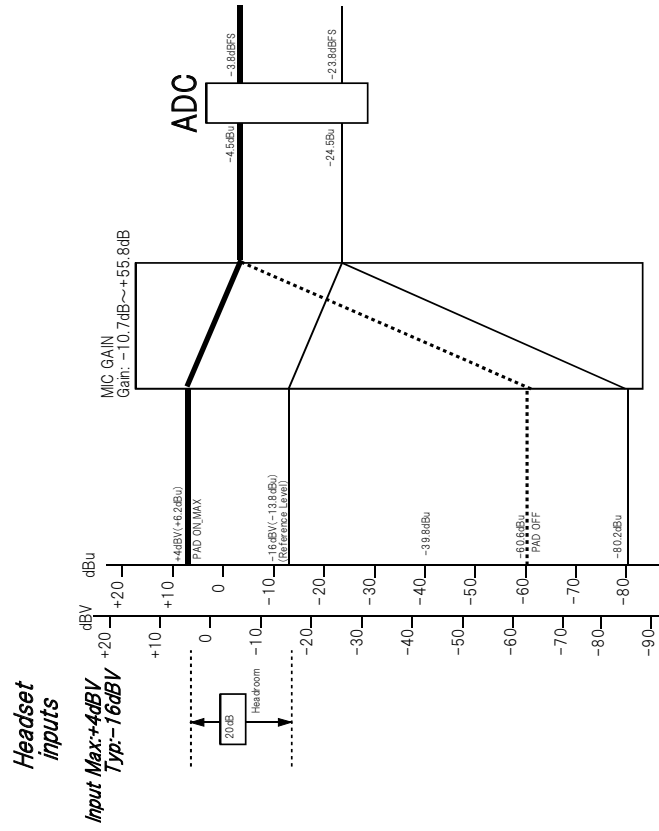

INPUT

Mixcast4 Level Diagram

OUTPUT

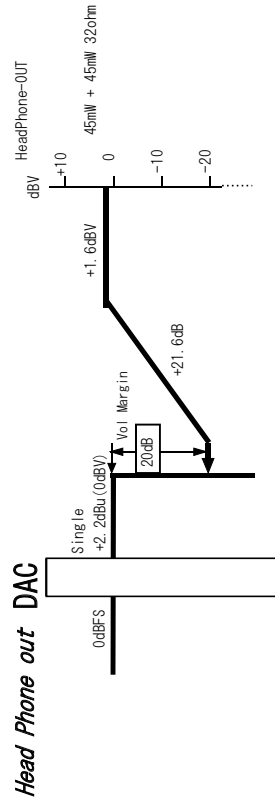
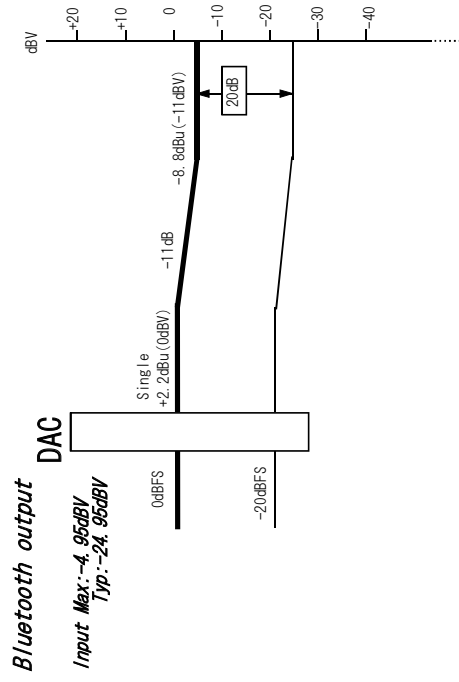
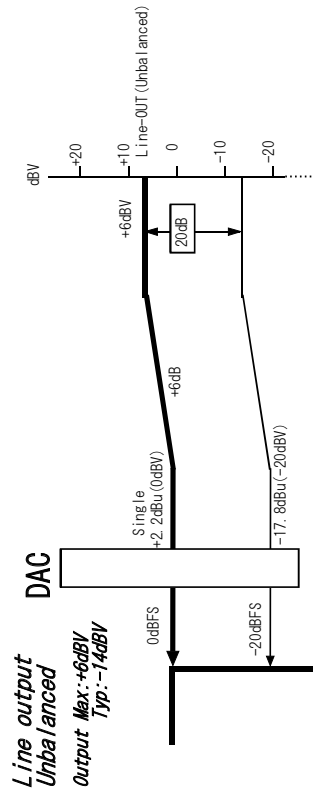
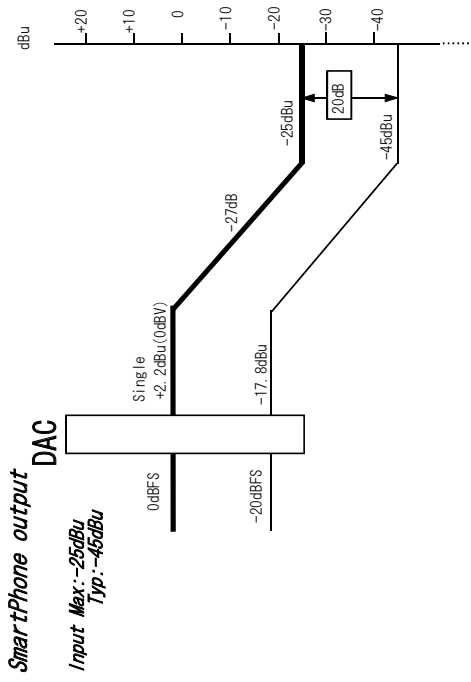
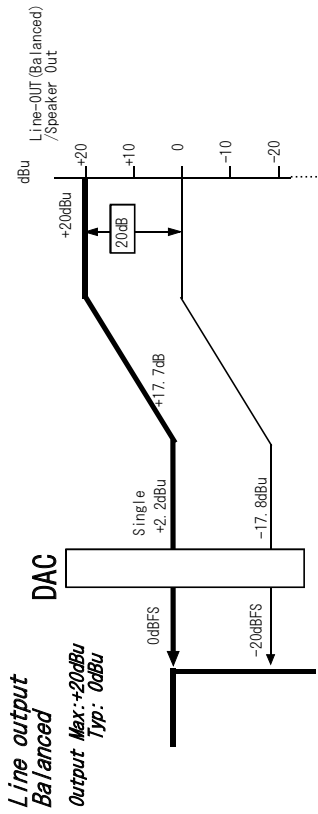

Mixcast4 Level Diagram

# TASCAM

## TEAC CORPORATION

<https://tascam.jp/jp/>

Phone: +81-42-356-9143  
1-47 Ochiai, Tama-shi, Tokyo 206-8530 Japan

---

## TEAC AMERICA, INC.

<https://tascam.com/us/>

Phone: +1-323-726-0303  
10410 Pioneer Blvd., Unit #1 Santa Fe Springs, California 90670, U.S.A

---

## TEAC UK Ltd.

<https://www.tascam.eu/en/>

Phone: +44-1923-797205  
Luminous House, 300 South Row, Milton Keynes, Buckinghamshire, MK9 2FR, UK

---

## TEAC EUROPE GmbH

<https://www.tascam.eu/de/>

Phone: +49-611-71580  
Bahnstrasse 12, 65205 Wiesbaden-Erbenheim, Germany

---

## TEAC SALES & TRADING(SHENZHEN) CO., LTD

<https://tascam.cn/cn>

Phone: +86-755-88311561~2  
Room 817, Xinian Center A, Tairan Nine Road West, Shennan Road, Futian District, Shenzhen, Guangdong Province 518040, China

---

0722.MA-3230C